

 **SMANIA**
FURNISH YOUR STYLE

INDOORUPDATE
SMANIA**NEST**
PRICELIST



LISTINO PREZZI
PRICE LIST

INDOORUPDATE
SMANIA NEST
*INDOORUPDATE
SMANIA NEST*

3	IMBOTTITI <i>UPHOLSTERY</i>	53	CASSETTONI, COMODINI E MOBILI TRUCCO <i>DRESSERS, NIGHTSTANDS AND VANITY DESKS</i>
19	TAVOLI <i>TABLES</i>	57	ILLUMINAZIONE <i>LIGHTING</i>
27	SEDIE E SGABELLI <i>CHAIRS AND STOOLS</i>	65	TAPPETI <i>CARPETS</i>
31	CREDENZE <i>SIDEBOARDS</i>	71	PANNELLI DECORATIVI <i>DECORATIVE PANELS</i>
37	LIBRERIE / ESPOSITORI, PORTA TV, MOBILI BAR E CONTENITORI <i>BOOKCASES / SHOWCASES, HOME THEATRES, BAR UNITS AND CABINETS</i>	75	COMPLEMENTI <i>DECORATIVE OBJECTS</i>
39	SCRITTOI, SCRIVANIE E ALLUNGHI <i>DESKS AND DESK-EXTENSIONS</i>	79	CUSCINI, TESSUTI E CAMPIONARIO <i>CUSHIONS, FABRICS AND SAMPLES BOX</i>
41	SEDIE UFFICIO <i>OFFICE CHAIRS</i>	89	PELLI, TESSUTI, MATERIALI <i>LEATHERS, FABRICS, MATERIALS</i>
43	CONSOLLE <i>CONSOLE TABLES</i>	141	INDICE ALFABETICO <i>ALPHABETICAL INDEX</i>
45	SPECCHI <i>MIRRORS</i>	143	CONDIZIONI GENERALI DI VENDITA <i>GENERAL CONDITIONS OF SALE</i>
47	LETTI <i>BEDS</i>		

volume / volume 0,735 m³
colli / boxes 1

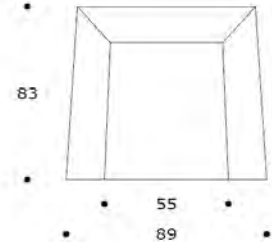
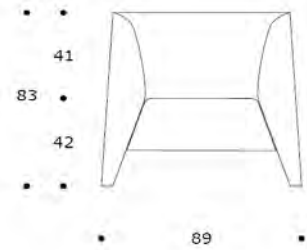
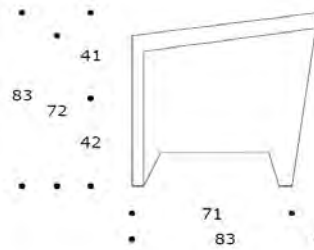

DESCRIZIONE / DESCRIPTION

CODICE / CODE

EURO / EURO

poltrona imbottita fissa a densità differenziata
fix padded armchair with differentiated polyurethane foam densities

PLABBY01

tessuto rivestimento

fabric finishing

tessuto cliente ml *6,50 / C.O.M. fabric lm *6,50

tessuto cat. B / fabric cat. B

tessuto cat. C / fabric cat. C

tessuto cat. D / fabric cat. D

tessuto cat. E / fabric cat. E

tessuto cat. F / fabric cat. F

tessuto cat. G / fabric cat. G

tessuto cat. LUX / fabric cat. LUX

1.920

2.500

2.685

2.845

3.200

3.540

3.780

4.820

pelle rivestimento

leather finishing

pelle cliente* / C.O.M. leather*

pelle cat. A / leather cat. A

pelle cat. B / leather cat. B

pelle cat. C / leather cat. C

pelle cat. D / leather cat. D

2.110

2.430

2.880

3.035

3.360

N.B. rivestimento in tessuto Amelie e Vamp non possibile

N.B. Amelie and Vamp fabric version not available

*TESSUTI E PELLI CLIENTE: La Smania Industria Italiana Mobili S.p.A., si riserva di verificare i materiali forniti dai clienti rispetto alle caratteristiche del prodotto e al tipo di rivestimento richiesto. Qualora questi materiali non siano considerati idonei, la stessa potrà decidere di non procedere con la lavorazione o, nel caso, di abbeditare, previa comunicazione al cliente, un sovrapprezzo. *C.O.M. fabric & C.O.M. leather: Smania Industria Italiana Mobili S.p.A. reserves the right to verify the characteristics of the materials supplied by the customer and also the kind of materials requested. If the materials are not suitable to fit, we may consider not to accept or add an extra charged for possible extra workmanship, after notice.

* i tessuti sono calcolati senza rapporto / fabrics are calculated without repeat

CHARLOTTE 280 | DVCHARLO01

DIVANO | SOFA

volume / volume 2,693 m³
colli / boxes 1

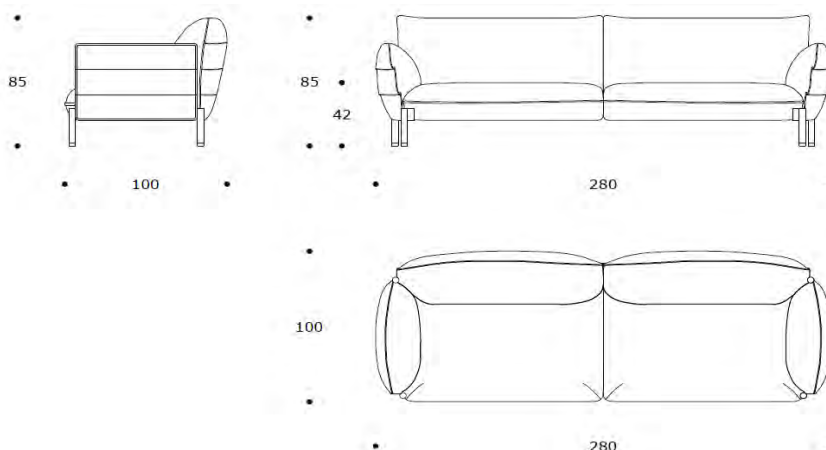

DESCRIZIONE / DESCRIPTION

CODICE / CODE

EURO / EURO

divano imbottito fisso a densità differenziate, piedi in acciaio rivestiti in cuoio testa di moro, particolari in acciaio finitura antracite
fix padded sofa with differentiated polyurethane foam densities, steel legs covered with "testa di moro" hide, charcoal grey finishing details

DVCHARLO01

tessuto rivestimento
fabric finishing

tessuto cliente ml *13,50 / C.O.M. fabric lm *13,50
tessuto cat. B / fabric cat. B
tessuto cat. C / fabric cat. C
tessuto cat. D / fabric cat. D
tessuto cat. E / fabric cat. E
tessuto cat. F / fabric cat. F
tessuto cat. G / fabric cat. G
tessuto cat. LUX / fabric cat. LUX

5.225
6.550
6.945
7.215
8.025
8.755
9.245
11.450

pelle rivestimento
leather finishing

pelle cliente* / C.O.M. leather*
pelle cat. A / leather cat. A
pelle cat. B / leather cat. B
pelle cat. C / leather cat. C
pelle cat. D / leather cat. D

5.850
6.500
7.650
8.030
8.830

altro rivestimento
feet
other feet finishings

pelle cliente* / C.O.M. leather*
pelle cat. A-B-C-D / leather cat. A-B-C-D

sovrapprezzo / surcharge

200

N.B. rivestimento in tessuto Amelie e Vamp non possibile
N.B. Amelie and Vamp fabric version not available

*TESSUTI E PELLI CLIENTE: La Smania Industria Italiana Mobili S.p.A., si riserva di verificare i materiali forniti dai clienti rispetto alle caratteristiche del prodotto e al tipo di rivestimento richiesto. Qualora questi materiali non siano considerati idonei, la stessa potrà decidere di non procedere con la lavorazione o, nel caso, di abbeditare, previa comunicazione al cliente, un sovrapprezzo. *C.O.M. fabric & C.O.M. leather: Smania Industria Italiana Mobili S.p.A. reserves the right to verify the characteristics of the materials supplied by the customer and also the kind of materials requested. If the materials are not suitable to fit, we may consider not to accept or add an extra charged for possible extra workmanship, after notice.

* i tessuti sono calcolati senza rapporto / fabrics are calculated without repeat

DIVANO | SOFA

volume / volume 2,315 m³
colli / boxes 1

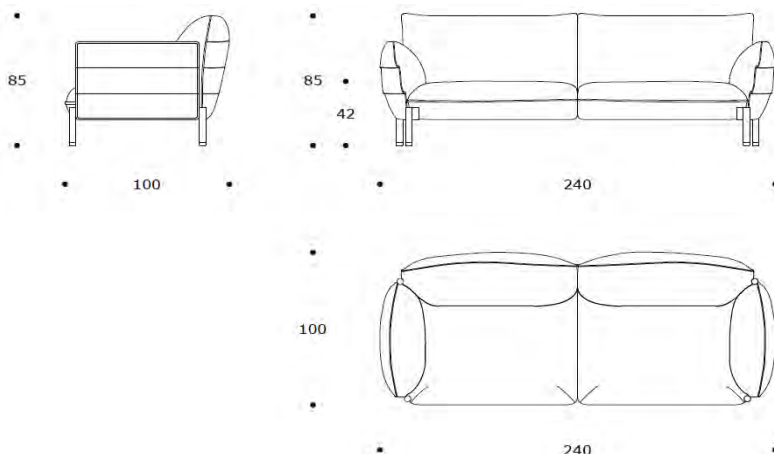

DESCRIZIONE / DESCRIPTION

CODICE / CODE

EURO / EURO

divano imbottito fisso a densità differenziate, piedi in acciaio rivestiti in cuoio testa di moro, particolari in acciaio finitura antracite
fix padded sofa with differentiated polyurethane foam densities, steel legs covered with "testa di moro" hide, charcoal grey finishing details

DVCHARLO02

tessuto rivestimento
fabric finishing

tessuto cliente ml *12,00 / C.O.M. fabric lm *12,00

tessuto cat. B / fabric cat. B

tessuto cat. C / fabric cat. C

tessuto cat. D / fabric cat. D

tessuto cat. E / fabric cat. E

tessuto cat. F / fabric cat. F

tessuto cat. G / fabric cat. G

tessuto cat. LUX / fabric cat. LUX

5.160

6.285

6.640

6.950

7.620

8.285

2.730

10.740

pelle rivestimento
leather finishing

pelle cliente* / C.O.M. leather*

pelle cat. A / leather cat. A

pelle cat. B / leather cat. B

pelle cat. C / leather cat. C

pelle cat. D / leather cat. D

5.675

6.325

7.380

7.765

8.525

altro rivestimento
piedi
other feet finishings

pelle cliente* / C.O.M. leather*

pelle cat. A-B-C-D / leather cat. A-B-C-D

sovrapprezzo / surcharge

200

N.B. rivestimento in tessuto Amelie e Vamp non possibile
N.B. Amelie and Vamp fabric version not available

*TESSUTI E PELLI CLIENTE: La Smania Industria Italiana Mobili S.p.A., si riserva di verificare i materiali forniti dai clienti rispetto alle caratteristiche del prodotto e al tipo di rivestimento richiesto. Qualora questi materiali non siano considerati idonei, la stessa potrà decidere di non procedere con la lavorazione o, nel caso, di abbeditare, previa comunicazione al cliente, un sovrapprezzo. *C.O.M. fabric & C.O.M. leather: Smania Industria Italiana Mobili S.p.A. reserves the right to verify the characteristics of the materials supplied by the customer and also the kind of materials requested. If the materials are not suitable to fit, we may consider not to accept or add an extra charged for possible extra workmanship, after notice.

* i tessuti sono calcolati senza rapporto / fabrics are calculated without repeat

CHARLOTTE 210 | DVCHARLO03

DIVANO | SOFA

volume / volume 2,032 m³
colli / boxes 1

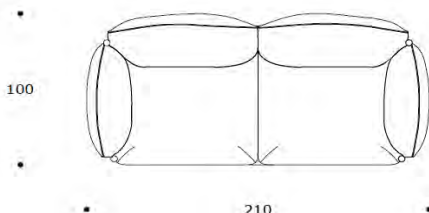
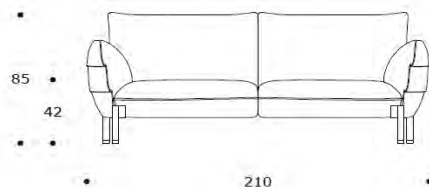
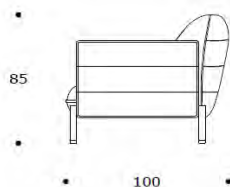

DESCRIZIONE / DESCRIPTION

CODICE / CODE

EURO / EURO

divano imbottito fisso a densità differenziate, piedi in acciaio rivestiti in cuoio testa di moro, particolari in acciaio finitura antracite
fix padded sofa with differentiated polyurethane foam densities, steel legs covered with "testa di moro" hide, charcoal grey finishing details

DVCHARLO03

tessuto rivestimento fabric finishing

tessuto cliente ml *11,50 / C.O.M. fabric 1m *11,50
tessuto cat. B / fabric cat. B
tessuto cat. C / fabric cat. C
tessuto cat. D / fabric cat. D
tessuto cat. E / fabric cat. E
tessuto cat. F / fabric cat. F
tessuto cat. G / fabric cat. G
tessuto cat. LUX / fabric cat. LUX

4.970
6.150
6.505
6.820
7.450
8.165
8.615
10.635

pelle rivestimento leather finishing

pelle cliente* / C.O.M. leather*
pelle cat. A / leather cat. A
pelle cat. B / leather cat. B
pelle cat. C / leather cat. C
pelle cat. D / leather cat. D

5.465
6.095
7.105
7.465
8.185

altro rivestimento piedi

other feet finishings

pelle cliente* / C.O.M. leather*
pelle cat. A-B-C-D / leather cat. A-B-C-D

sovrapprezzo / surcharge

200

N.B. rivestimento in tessuto Amelie e Vamp non possibile N.B. Amelie and Vamp fabric version not available

*TESSUTI E PELLI CLIENTE: La Smania Industria Italiana Mobili S.p.A., si riserva di verificare i materiali forniti dai clienti rispetto alle caratteristiche del prodotto e al tipo di rivestimento richiesto. Qualora questi materiali non siano considerati idonei, la stessa potrà decidere di non procedere con la lavorazione o, nel caso, di abbeditare, previa comunicazione al cliente, un sovrapprezzo. *C.O.M. fabric & C.O.M. leather: Smania Industria Italiana Mobili S.p.A. reserves the right to verify the characteristics of the materials supplied by the customer and also the kind of materials requested. If the materials are not suitable to fit, we may consider not to accept or add an extra charged for possible extra workmanship, after notice.

* i tessuti sono calcolati senza rapporto / fabrics are calculated without repeat

POLTRONA | ARMCHAIR

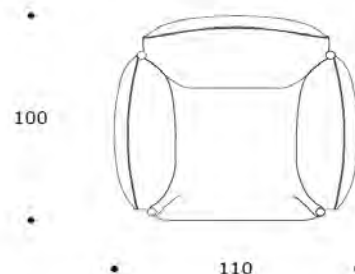
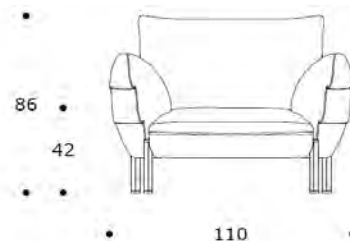
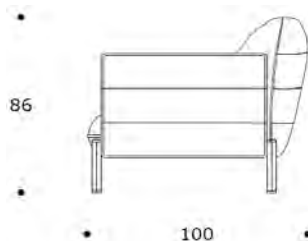
 volume / volume 1,087 m³
 colli / boxes 1

DESCRIZIONE / DESCRIPTION
CODICE / CODE
EURO / EURO

poltrona imbottita fissa a densità differenziate, piedi in acciaio rivestiti in cuoio testa di moro, particolari in acciaio finitura antracite
fix padded armchair with differentiated polyurethane foam densities, steel legs covered with "testa di moro" hide, charcoal grey finishing details

PLCHARLO01

tessuto rivestimento
fabric finishing

tessuto cliente ml *7,00 / C.O.M. fabric lm *7,00

tessuto cat. B / fabric cat. B

tessuto cat. C / fabric cat. C

tessuto cat. D / fabric cat. D

tessuto cat. E / fabric cat. E

tessuto cat. F / fabric cat. F

tessuto cat. G / fabric cat. G

tessuto cat. LUX / fabric cat. LUX

3.240
3.840
4.030
4.195
4.560
4.920
5.160
6.240
pelle rivestimento
leather finishing

pelle cliente* / C.O.M. leather*

pelle cat. A / leather cat. A

pelle cat. B / leather cat. B

pelle cat. C / leather cat. C

pelle cat. D / leather cat. D

3.565
3.815
4.320
4.495
4.855
altro rivestimento
piedi
other feet finishings

pelle cliente* / C.O.M. leather*

pelle cat. A-B-C-D / leather cat. A-B-C-D

sovrapprezzo / surcharge

200
N.B. rivestimento in tessuto Amelie e Vamp non possibile
N.B. Amelie and Vamp fabric version not available

*TESSUTI E PELLI CLIENTE: La Smania Industria Italiana Mobili S.p.A., si riserva di verificare i materiali forniti dai clienti rispetto alle caratteristiche del prodotto e al tipo di rivestimento richiesto. Qualora questi materiali non siano considerati idonei, la stessa potrà decidere di non procedere con la lavorazione o, nel caso, di abbeditare, previa comunicazione al cliente, un sovrapprezzo. *C.O.M. fabric & C.O.M. leather: Smania Industria Italiana Mobili S.p.A. reserves the right to verify the characteristics of the materials supplied by the customer and also the kind of materials requested. If the materials are not suitable to fit, we may consider not to accept or add an extra charged for possible extra workmanship, after notice.

* i tessuti sono calcolati senza rapporto / fabrics are calculated without repeat

CHARME 280 | DVCHARME01

DIVANO | SOFA

volume / volume 2,665 m³
colli / boxes 1

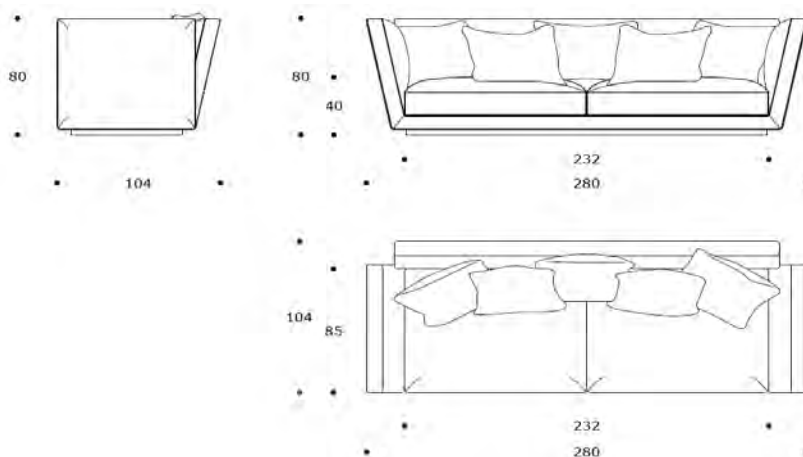

DESCRIZIONE / DESCRIPTION

CODICE / CODE

divano imbottito fisso a densità differenziate, cuscini di seduta sfoderabili,
n.5 cuscini 50x50 con nervetto
*fix padded sofa with differentiated polyurethane foam densities, seat removable cushions,
n.5 cushions 50x50 with trimming*

DVCHARME01

EURO / EURO

EURO / EURO

rivestimento scocca esterna
external structure finishing

tessuto cliente ml *4,50 / C.O.M. fabric lm *4,50
tessuto cat. B / fabric cat. B **1.320**
tessuto cat. C / fabric cat. C **1.410**
tessuto cat. D / fabric cat. D **1.490**
tessuto cat. E / fabric cat. E **1.745**
tessuto cat. F / fabric cat. F **1.955**
tessuto cat. G / fabric cat. G **2.095**
tessuto cat. LUX / fabric cat. LUX **2.655**

pelle cliente* / C.O.M. leather* **1.010**
pelle cat. A / leather cat. A **1.285**
pelle cat. B / leather cat. B **1.625**
pelle cat. C / leather cat. C **1.745**
pelle cat. D / leather cat. D **1.985**

rivestimento cuscini e scocca interna
cushions and internal structure finishing

tessuto cliente ml *12,50 / C.O.M. fabric lm *12,50 **3.455**
tessuto cat. B / fabric cat. B **5.080**
tessuto cat. C / fabric cat. C **5.435**
tessuto cat. D / fabric cat. D **5.750**
tessuto cat. E / fabric cat. E **6.715**
tessuto cat. F / fabric cat. F **7.540**
tessuto cat. G / fabric cat. G **8.080**
tessuto cat. LUX / fabric cat. LUX **10.625**

pelle cliente* / C.O.M. leather* **3.885**
pelle cat. A / leather cat. A **4.940**
pelle cat. B / leather cat. B **6.255**
pelle cat. C / leather cat. C **6.720**
pelle cat. D / leather cat. D **7.660**

N.B. rivestimento in tessuto Amelie e Vamp non possibile
N.B. Amelie and Vamp fabric version not available

*TESSUTI E PELLI CLIENTE: La Smania Industria Italiana Mobili S.p.A., si riserva di verificare i materiali forniti dai clienti rispetto alle caratteristiche del prodotto e al tipo di rivestimento richiesto. Qualora questi materiali non siano considerati idonei, la stessa potrà decidere di non procedere con la lavorazione o, nel caso, di abbeditare, previa comunicazione al cliente, un sovrapprezzo. *C.O.M. fabric & C.O.M. leather: Smania Industria Italiana Mobili S.p.A. reserves the right to verify the characteristics of the materials supplied by the customer and also the kind of materials requested. If the materials are not suitable to fit, we may consider not to accept or add an extra charged for possible extra workmanship, after notice.

* i tessuti sono calcolati senza rapporto / fabrics are calculated without repeat

DIVANO | SOFA

volume / volume 2,291 m³
colli / boxes 1

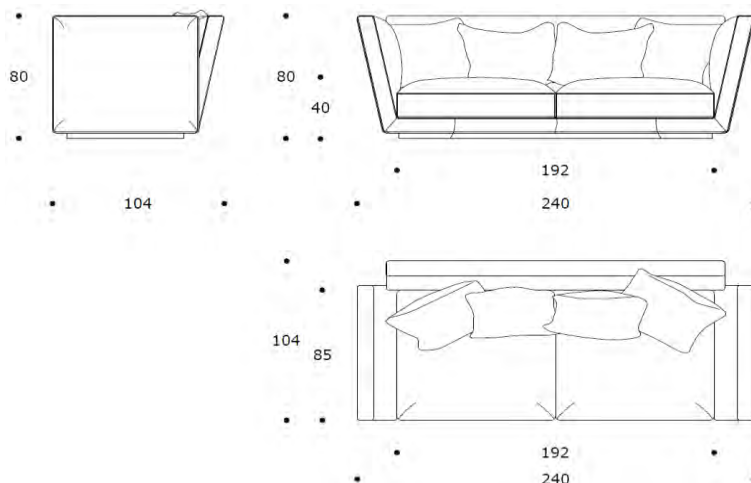

DESCRIZIONE / DESCRIPTION

CODICE / CODE

divano imbottito fisso a densità differenziate, cuscini di seduta sfoderabili,
n.4 cuscini 50x50 con nervetto
fix padded sofa with differentiated polyurethane foam densities, seat removable cushions,
n.4 cushions 50x50 with trimming

DVCHARME02

EURO / EURO

EURO / EURO

rivestimento scocca esterna
external structure finishing

tessuto cliente ml *4,00 / C.O.M. fabric lm *4,00
tessuto cat. B / fabric cat. B
tessuto cat. C / fabric cat. C
tessuto cat. D / fabric cat. D
tessuto cat. E / fabric cat. E
tessuto cat. F / fabric cat. F
tessuto cat. G / fabric cat. G
tessuto cat. LUX / fabric cat. LUX

835
1.190
1.295
1.385
1.580
1.775
1.905
2.495

rivestimento cuscini e scocca interna
cushions and internal structure finishing

tessuto cliente ml *12,50 / C.O.M. fabric lm *12,50
tessuto cat. B / fabric cat. B
tessuto cat. C / fabric cat. C
tessuto cat. D / fabric cat. D
tessuto cat. E / fabric cat. E
tessuto cat. F / fabric cat. F
tessuto cat. G / fabric cat. G
tessuto cat. LUX / fabric cat. LUX

3.215
4.590
4.990
5.345
6.095
6.845
7.350
9.610

pelle cliente* / C.O.M. leather*
pelle cat. A / leather cat. A
pelle cat. B / leather cat. B
pelle cat. C / leather cat. C
pelle cat. D / leather cat. D

950
1.195
1.505
1.615
1.835

pelle cliente* / C.O.M. leather*
pelle cat. A / leather cat. A
pelle cat. B / leather cat. B
pelle cat. C / leather cat. C
pelle cat. D / leather cat. D

3.660
4.600
5.790
6.215
7.065

N.B. rivestimento in tessuto Amelie e Vamp non possibile
N.B. Amelie and Vamp fabric version not available

*TESSUTI E PELLI CLIENTE: La Smania Industria Italiana Mobili S.p.A., si riserva di verificare i materiali forniti dai clienti rispetto alle caratteristiche del prodotto e al tipo di rivestimento richiesto. Qualora questi materiali non siano considerati idonei, la stessa potrà decidere di non procedere con la lavorazione o, nel caso, di abbeditare, previa comunicazione al cliente, un sovrapprezzo. *C.O.M. fabric & C.O.M. leather: Smania Industria Italiana Mobili S.p.A. reserves the right to verify the characteristics of the materials supplied by the customer and also the kind of materials requested. If the materials are not suitable to fit, we may consider not to accept or add an extra charged for possible extra workmanship, after notice.

* i tessuti sono calcolati senza rapporto / fabrics are calculated without repeat

CHARME 210 | DVCHARME03

DIVANO | SOFA

volume / volume 2,010 m³
colli / boxes 1

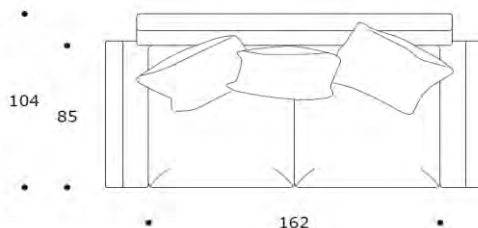
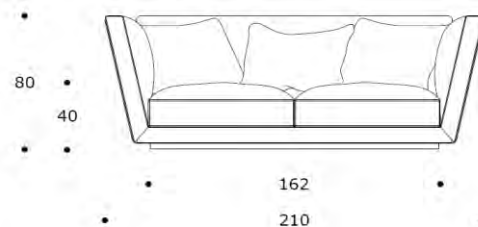
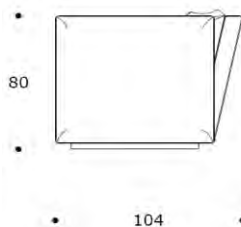

DESCRIZIONE / DESCRIPTION

CODICE / CODE

divano imbottito fisso a densità differenziate, cuscini di seduta sfoderabili,
n.3 cuscini 50x50 con nervetto
*fix padded sofa with differentiated polyurethane foam densities, seat removable cushions,
n.3 cushions 50x50 with trimming*

DVCHARME03

EURO / EURO

EURO / EURO

rivestimento scocca esterna
external structure finishing

tessuto cliente ml *3,50 / C.O.M. fabric lm *3,50
tessuto cat. B / fabric cat. B **1.080**
tessuto cat. C / fabric cat. C **1.180**
tessuto cat. D / fabric cat. D **1.265**
tessuto cat. E / fabric cat. E **1.450**
tessuto cat. F / fabric cat. F **1.630**
tessuto cat. G / fabric cat. G **1.755**
tessuto cat. LUX / fabric cat. LUX **2.305**

pelle cliente* / C.O.M. leather* **840**
pelle cat. A / leather cat. A **1.085**
pelle cat. B / leather cat. B **1.370**
pelle cat. C / leather cat. C **1.470**
pelle cat. D / leather cat. D **1.675**

rivestimento cuscini e scocca interna
cushions and internal structure finishing

tessuto cliente ml *8,50 / C.O.M. fabric lm *8,50 **2.955**
tessuto cat. B / fabric cat. B **4.170**
tessuto cat. C / fabric cat. C **4.550**
tessuto cat. D / fabric cat. D **4.880**
tessuto cat. E / fabric cat. E **5.585**
tessuto cat. F / fabric cat. F **6.295**
tessuto cat. G / fabric cat. G **6.760**
tessuto cat. LUX / fabric cat. LUX **8.890**

pelle cliente* / C.O.M. leather* **3.240**
pelle cat. A / leather cat. A **4.175**
pelle cat. B / leather cat. B **5.280**
pelle cat. C / leather cat. C **5.665**
pelle cat. D / leather cat. D **6.450**

N.B. rivestimento in tessuto Amelie e Vamp non possibile
N.B. Amelie and Vamp fabric version not available

*TESSUTE E PELLI CLIENTE: La Smania Industria Italiana Mobili S.p.A., si riserva di verificare i materiali forniti dai clienti rispetto alle caratteristiche del prodotto e al tipo di rivestimento richiesto. Qualora questi materiali non siano considerati idonei, la stessa potrà decidere di non procedere con la lavorazione o, nel caso, di abbeditare, previa comunicazione al cliente, un sovrapprezzo. *C.O.M. fabric & C.O.M. leather: Smania Industria Italiana Mobili S.p.A. reserves the right to verify the characteristics of the materials supplied by the customer and also the kind of materials requested. If the materials are not suitable to fit, we may consider not to accept or add an extra charged for possible extra workmanship, after notice.

* i tessuti sono calcolati senza rapporto / fabrics are calculated without repeat

POLTRONA | ARMCHAIR

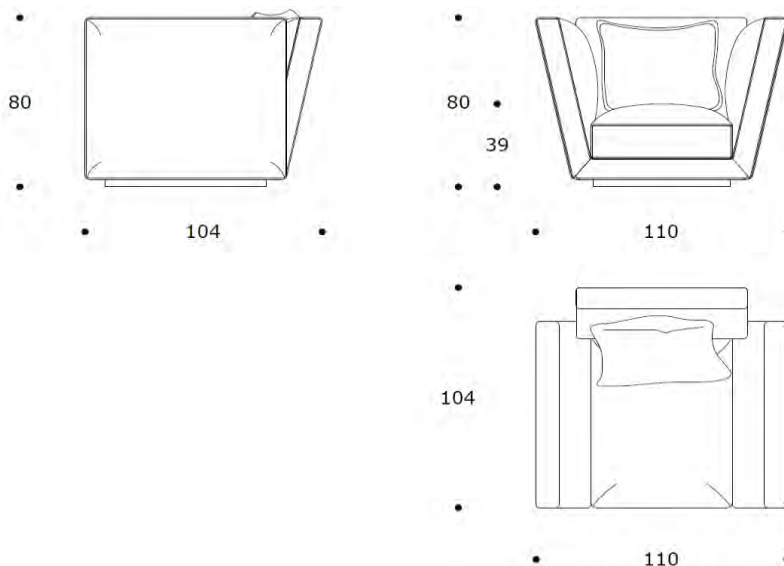
 volume / volume 1,075 m³
colli / boxes 1

DESCRIZIONE / DESCRIPTION

CODICE / CODE

poltrona imbottita fissa a densità differenziate, cuscino di seduta sfoderabile,
n.1 cuscino 50x50 con nervetto
fix padded armchair with differentiated polyurethane foam densities, seat removable cushion,
n.1 cushion 50x50 with trimming

DVCHARME02

EURO / EURO

EURO / EURO

rivestimento scocca esterna
external structure finishing

tessuto cliente ml *2,50 / C.O.M. fabric lm *2,50
tessuto cat. B / fabric cat. B
tessuto cat. C / fabric cat. C
tessuto cat. D / fabric cat. D
tessuto cat. E / fabric cat. E
tessuto cat. F / fabric cat. F
tessuto cat. G / fabric cat. G
tessuto cat. LUX / fabric cat. LUX

470
635
685
730
820
915
980
1.260

rivestimento cuscino e scocca interna
cushion and internal structure finishing

tessuto cliente ml *5,80 / C.O.M. fabric lm *5,80
tessuto cat. B / fabric cat. B
tessuto cat. C / fabric cat. C
tessuto cat. D / fabric cat. D
tessuto cat. E / fabric cat. E
tessuto cat. F / fabric cat. F
tessuto cat. G / fabric cat. G
tessuto cat. LUX / fabric cat. LUX

1.810
2.440
2.630
2.800
3.170
3.530
3.775
4.865

pelle cliente* / C.O.M. leather*
pelle cat. A / leather cat. A
pelle cat. B / leather cat. B
pelle cat. C / leather cat. C
pelle cat. D / leather cat. D

525
635
780
830
935

pelle cliente* / C.O.M. leather*
pelle cat. A / leather cat. A
pelle cat. B / leather cat. B
pelle cat. C / leather cat. C
pelle cat. D / leather cat. D

2.015
2.460
3.010
3.285
3.595

N.B. rivestimento in tessuto Amelie e Vamp non possibile
N.B. Amelie and Vamp fabric version not available

*TESSUTI E PELLI CLIENTE: La Smania Industria Italiana Mobili S.p.A., si riserva di verificare i materiali forniti dai clienti rispetto alle caratteristiche del prodotto e al tipo di rivestimento richiesto. Qualora questi materiali non siano considerati idonei, la stessa potrà decidere di non procedere con la lavorazione o, nel caso, di abbeditare, previa comunicazione al cliente, un sovrapprezzo. *C.O.M. fabric & C.O.M. leather: Smania Industria Italiana Mobili S.p.A. reserves the right to verify the characteristics of the materials supplied by the customer and also the kind of materials requested. If the materials are not suitable to fit, we may consider not to accept or add an extra charged for possible extra workmanship, after notice.

* i tessuti sono calcolati senza rapporto / fabrics are calculated without repeat

POLTRONA | *ARMCHAIR*

volume / volume 0,510 m³
colli / boxes 1

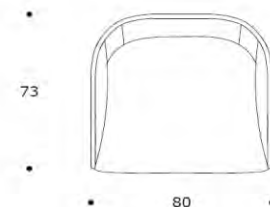
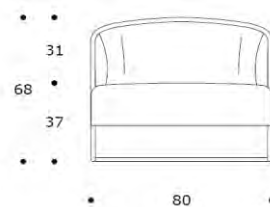
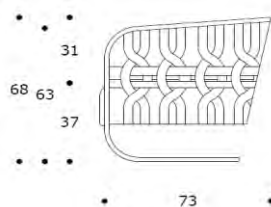

DESCRIZIONE / DESCRIPTION

CODICE / CODE

EURO / EURO

poltrona imbottita fissa a densità differenziate, particolari in cuoio intrecciato, base in acciaio nichel nero lucido o spazzolato
fix padded armchair with differentiated polyurethane foam densities, woven hide details, polished black nickel or brushed steel base

PLELLEN01

tessuto rivestimento
fabric finishing

tessuto cliente ml *4,00 / C.O.M. fabric lm *4,00
tessuto cat. B / fabric cat. B
tessuto cat. C / fabric cat. C
tessuto cat. D / fabric cat. D
tessuto cat. E / fabric cat. E
tessuto cat. F / fabric cat. F
tessuto cat. G / fabric cat. G
tessuto cat. LUX / fabric cat. LUX

2.590
2.900
3.005
3.095
3.285
3.475
3.600
4.170

pelle rivestimento
leather finishing

pelle cliente* / C.O.M. leather*
pelle cat. A / leather cat. A
pelle cat. B / leather cat. B
pelle cat. C / leather cat. C
pelle cat. D / leather cat. D

3.165
3.250
3.580
3.820
3.980

finitura cuoio
hide finishing

sabbia / sand
testa di moro / testa di moro

finitura base
base finishing

acciaio / stainless steel
oro rosa / gold rose
brunito spazzolato / brushed bronzed
nichel spazzolato / brushed nickel

sovrapprezzo / surcharge 120
sovrapprezzo / surcharge 120
sovrapprezzo / surcharge 140
sovrapprezzo / surcharge 160

N.B. rivestimento in tessuto Amelie e Vamp non possibile
N.B. Amelie and Vamp fabric version not available

*TESSUTI E PELLI CLIENTE: La Smania Industria Italiana Mobili S.p.A., si riserva di verificare i materiali forniti dai clienti rispetto alle caratteristiche del prodotto e al tipo di rivestimento richiesto. Qualora questi materiali non siano considerati idonei, la stessa potrà decidere di non procedere con la lavorazione o, nel caso, di abbeditare, previa comunicazione al cliente, un sovrapprezzo. *C.O.M. fabric & C.O.M. leather: Smania Industria Italiana Mobili S.p.A. reserves the right to verify the characteristics of the materials supplied by the customer and also the kind of materials requested. If the materials are not suitable to fit, we may consider not to accept or add an extra charged for possible extra workmanship, after notice.

* i tessuti sono calcolati senza rapporto / fabrics are calculated without repeat

DIVANO | SOFA

volume / volume 2,021 m³
colli / boxes 1

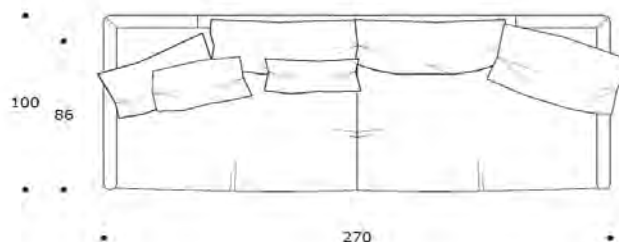
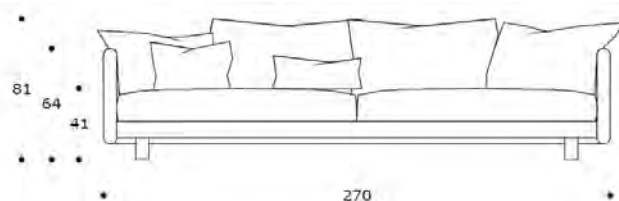
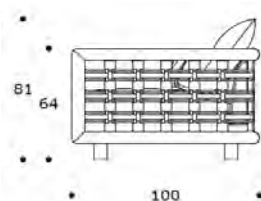

DESCRIZIONE / DESCRIPTION		CODICE / CODE	EURO / EURO
divano in massello di frassino con dettagli in cuoio intrecciato, schienale e base imbottiti fissi, cuscini di seduta, schienale, n.1 75x75, n.1 65x65 a densità differenziata e sfoderabili, piedi in legno tinto <i>solid ash wood sofa with woven hide details, fix padded back and base, seat, back, n.1 75x75, n.1 65x65, removable cushions with differentiated polyurethane foam densities, tinted wood feet</i>		DVKILLIA01	
tessuto rivestimento <i>fabric finishing</i>	tessuto cliente ml *17,00 / C.O.M. fabric lm *17,00 tessuto cat. B / fabric cat. B tessuto cat. C / fabric cat. C tessuto cat. D / fabric cat. D tessuto cat. E / fabric cat. E tessuto cat. F / fabric cat. F tessuto cat. G / fabric cat. G tessuto cat. LUX / fabric cat. LUX		5.570 6.900 7.330 7.705 8.500 9.300 9.835 12.235
pelle rivestimento <i>leather finishing</i>	pelle cliente* / C.O.M. leather* pelle cat. A / leather cat. A pelle cat. B / leather cat. B pelle cat. C / leather cat. C pelle cat. D / leather cat. D		6.125 7.000 8.250 8.695 9.590
finitura massello di frassino <i>solid ash wood finishing</i>	miele / honey moka / moka		
finitura cuoio <i>hide finishing</i>	sabbia / sand testa di moro / testa di moro		
altre versioni <i>other versions</i>	versione personalizzata tessuto o pelle <i>personalized version fabric or leather</i>	sovrapprezzo / surcharge	500

N.B. il sovrapprezzo "altre versioni" è da aggiungere al prezzo della categoria di tessuto o pelle seduta e schienale scelta

N.B. "other versions" surcharge has to be added to the selected seat and back fabric or leather category

N.B. rivestimento in tessuto Amelie e Vamp non possibile

N.B. Amelie and Vamp fabric version not available

*TESSUTI E PELLI CLIENTE: La Smania Industria Italiana Mobili S.p.A., si riserva di verificare i materiali forniti dai clienti rispetto alle caratteristiche del prodotto e al tipo di rivestimento richiesto. Qualora questi materiali non siano considerati idonei, la stessa potrà decidere di non procedere con la lavorazione o, nel caso, di abbeditare, previa comunicazione al cliente, un sovrapprezzo. *C.O.M. fabric & C.O.M. leather: Smania Industria Italiana Mobili S.p.A. reserves the right to verify the characteristics of the materials supplied by the customer and also the kind of materials requested. If the materials are not suitable to fit, we may consider not to accept or add an extra charged for possible extra workmanship, after notice.

* i tessuti sono calcolati senza rapporto / fabrics are calculated without repeat

KILLIAN 235 | DVKILLIA02

DIVANO | SOFA

volume / volume 1,765 m³
colli / boxes 1

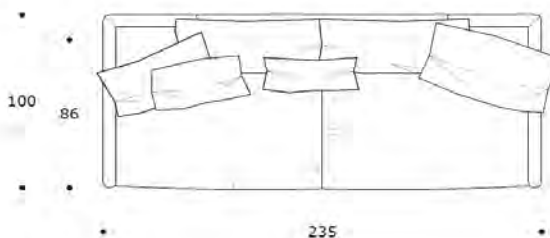
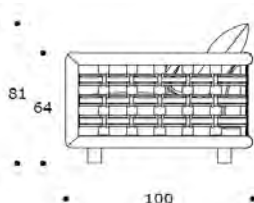

DESCRIZIONE / DESCRIPTION

CODICE / CODE

EURO / EURO

divano in massello di frassino con dettagli in cuoio intrecciato, schienale e base imbottiti fissi, cuscini di seduta, schienale, n.1 75x75, n.1 65x65, a densità differenziate e sfoderabili, piedi in legno tinto
solid ash wood sofa with woven hide details, fix padded back and base, seat, back, n.1 75x75, n.1 65x65, removable cushions with differentiated polyurethane foam densities, tinted wood feet

DVKILLIA02

tessuto rivestimento fabric finishing

tessuto cliente ml *15,00 / C.O.M. fabric lm *15,00

tessuto cat. B / fabric cat. B

tessuto cat. C / fabric cat. C

tessuto cat. D / fabric cat. D

tessuto cat. E / fabric cat. E

tessuto cat. F / fabric cat. F

tessuto cat. G / fabric cat. G

tessuto cat. LUX / fabric cat. LUX

5.160

6.400

6.790

7.135

7.875

8.620

9.115

11.340

pelle rivestimento leather finishing

pelle cliente* / C.O.M. leather*

pelle cat. A / leather cat. A

pelle cat. B / leather cat. B

pelle cat. C / leather cat. C

pelle cat. D / leather cat. D

5.675

6.535

7.735

8.165

9.025

finitura massello di frassino solid ash wood finishing

miele / honey

moka / moka

finitura cuoio hide finishing

sabbia / sand

testa di moro / testa di moro

altre versioni other versions

versione personalizzata tessuto o pelle
personalized version fabric or leather

sovrapprezzo / surcharge

500

N.B. il sovrapprezzo "altre versioni" è da aggiungere al prezzo della categoria di tessuto o pelle seduta e schienale scelta

N.B. "other versions" surcharge has to be added to the selected seat and back fabric or leather category

N.B. rivestimento in tessuto Amelie e Vamp non possibile

N.B. Amelie and Vamp fabric version not available

*TESSUTI E PELLI CLIENTE: La Smania Industria Italiana Mobili S.p.A., si riserva di verificare i materiali forniti dai clienti rispetto alle caratteristiche del prodotto e al tipo di rivestimento richiesto. Qualora questi materiali non siano considerati idonei, la stessa potrà decidere di non procedere con la lavorazione o, nel caso, di abbeditare, previa comunicazione al cliente, un sovrapprezzo. *C.O.M. fabric & C.O.M. leather: Smania Industria Italiana Mobili S.p.A. reserves the right to verify the characteristics of the materials supplied by the customer and also the kind of materials requested. If the materials are not suitable to fit, we may consider not to accept or add an extra charged for possible extra workmanship, after notice.

* i tessuti sono calcolati senza rapporto / fabrics are calculated without repeat

KILLIAN 345 angolo dx | DVKILLIA04

SMANIA

DIVANO | SOFA

IMBOTTITI
UPHOLSTERY

volume / volume 2,982 m³
colli / boxes 2

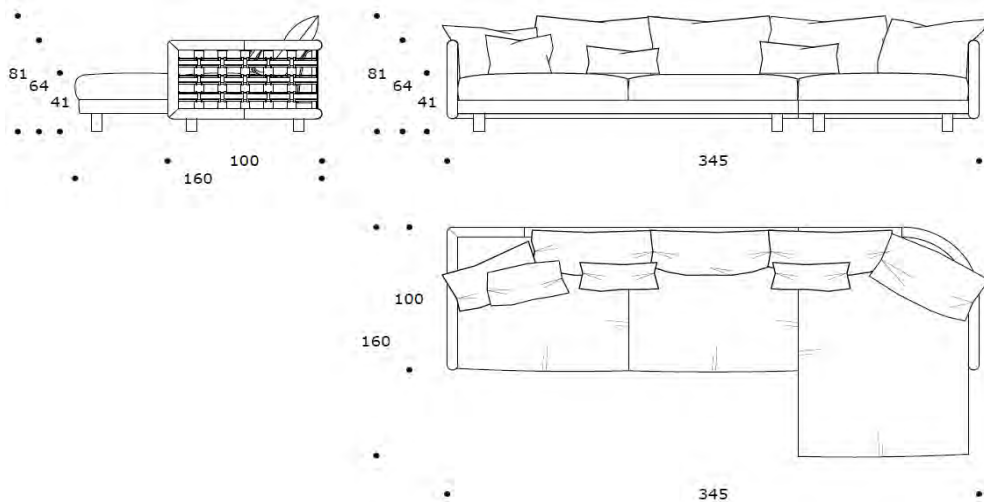

DESCRIZIONE / DESCRIPTION

CODICE / CODE

EURO / EURO

divano angolo in massello di frassino con dettagli in cuoio intrecciato, schienale e base imbottiti fissi, cuscini di seduta, schienale, n.1 75x75, n.1 65x65 a densità differenziate e sfoderabili, piedi in legno tinto
solid ash wood corner sofa with woven hide details, fix padded back and base, seat, back, n.1 75x75, n.1 65x65, removable cushions with differentiated polyurethane densities, tinted wood feet

DVKILLIA04

tessuto rivestimento
fabric finishing

tessuto cliente ml *27,00 / C.O.M. fabric lm *27,00

7.500

tessuto cat. B / fabric cat. B

9.200

tessuto cat. C / fabric cat. C

9.735

tessuto cat. D / fabric cat. D

10.230

tessuto cat. E / fabric cat. E

11.245

tessuto cat. F / fabric cat. F

12.265

tessuto cat. G / fabric cat. G

12.945

tessuto cat. LUX / fabric cat. LUX

16.010

pelle rivestimento
leather finishing

pelle cliente* / C.O.M. leather*

8.260

pelle cat. A / leather cat. A

9.450

pelle cat. B / leather cat. B

11.130

pelle cat. C / leather cat. C

11.745

pelle cat. D / leather cat. D

12.955

finitura massello di frassino
massive ash finishing

miele / honey

moka / moka

finitura cuoio
hide finishing

sabbia / sand

testa di moro / testa di moro

altre versioni
other versions

versione personalizzata tessuto o pelle
personalized version fabric or leather

sovrapprezzo / surcharge

600

N.B. il sovrapprezzo "altre versioni" è da aggiungere al prezzo della categoria di tessuto o pelle seduta e schienale scelta

N.B. "other versions" surcharge has to be added to the selected seat and back fabric or leather category

N.B. rivestimenti in tessuto Amelie e Vamp non possibile

N.B. Amelie and Vamp fabric version not available

*TESSUTI E PELLI CLIENTE: La Smania Industria Italiana Mobili S.p.A., si riserva di verificare i materiali forniti dai clienti rispetto alle caratteristiche del prodotto e al tipo di rivestimento richiesto. Qualora questi materiali non siano considerati idonei, la stessa potrà decidere di non procedere con la lavorazione o, nel caso, di abbeditare, previa comunicazione al cliente, un sovrapprezzo. *C.O.M. fabric & C.O.M. leather: Smania Industria Italiana Mobili S.p.A. reserves the right to verify the characteristics of the materials supplied by the customer and also the kind of materials requested. If the materials are not suitable to fit, we may consider not to accept or add an extra charged for possible extra workmanship, after notice.

* i tessuti sono calcolati senza rapporto / fabrics are calculated without repeat

KILLIAN 345 angolo sx | DVKILLIA05

DIVANO | SOFA

volume / volume 2,982 m³
colli / boxes 2

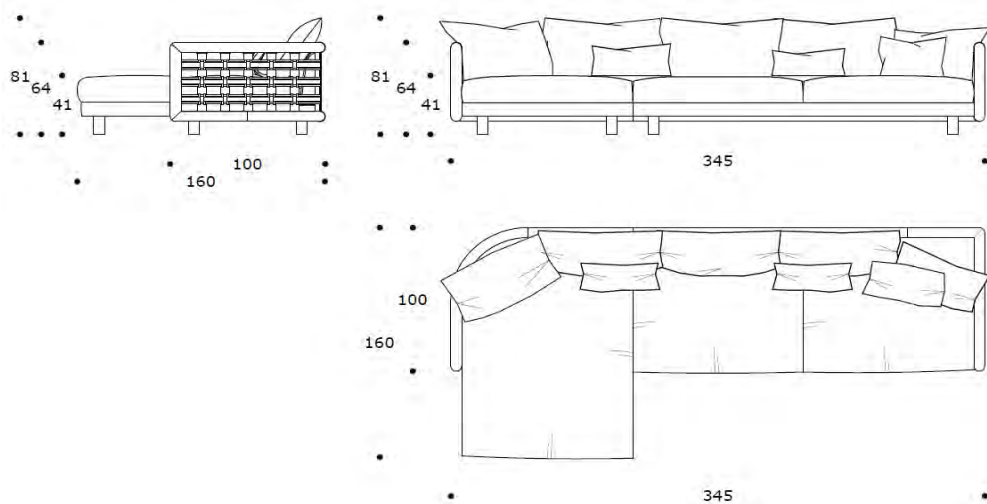

DESCRIZIONE / DESCRIPTION

CODICE / CODE

EURO / EURO

divano angolo in massello di frassino con dettagli in cuoio intrecciato, schienale e base imbottiti fissi, cuscini di seduta, schienale, n. 1 75x75, n. 1 65x65, a densità differenziate e sfoderabili, piedi in legno tinto
solid ash wood sofa with woven hide details, fix padded back and base, seat, back, n.1 75x75, n.1 65x65, removable cushions with differentiated polyurethane foam densities, tinted wood feet

DVKILLIA05

tessuto rivestimento fabric finishing

tessuto cliente ml *27,00 / C.O.M. fabric lm *27,00

tessuto cat. B / fabric cat. B

tessuto cat. C / fabric cat. C

tessuto cat. D / fabric cat. D

tessuto cat. E / fabric cat. E

tessuto cat. F / fabric cat. F

tessuto cat. G / fabric cat. G

tessuto cat. LUX / fabric cat. LUX

7.500

9.200

9.735

10.230

11.245

12.265

12.945

16.010

pelle rivestimento leather finishing

pelle cliente* / C.O.M. leather*

pelle cat. A / leather cat. A

pelle cat. B / leather cat. B

pelle cat. C / leather cat. C

pelle cat. D / leather cat. D

8.260

9.450

11.130

11.745

12.955

finitura massello di frassino

solid ash wood finishing

miele / honey

moka / moka

finitura cuoio hide finishing

sabbia / sand

testa di moro / testa di moro

altre versioni other versions

versione personalizzata tessuto o pelle
personalized version fabric or leather

sovrapprezzo / surcharge

600

N.B. il sovrapprezzo "altre versioni" è da aggiungere al prezzo della categoria di tessuto o pelle seduta e schienale scelta

N.B. "other versions" surcharge has to be added to the selected seat and back fabric or leather category

N.B. rivestimento in tessuto Amelie e Vamp non possibile

N.B. Amelie and Vamp fabric version not available

*TESSUTI E PELLI CLIENTE: La Smania Industria Italiana Mobili S.p.A., si riserva di verificare i materiali forniti dai clienti rispetto alle caratteristiche del prodotto e al tipo di rivestimento richiesto. Qualora questi materiali non siano considerati idonei, la stessa potrà decidere di non procedere con la lavorazione o, nel caso, di abbeditare, previa comunicazione al cliente, un sovrapprezzo. *C.O.M. fabric & C.O.M. leather: Smania Industria Italiana Mobili S.p.A. reserves the right to verify the characteristics of the materials supplied by the customer and also the kind of materials requested. If the materials are not suitable to fit, we may consider not to accept or add an extra charged for possible extra workmanship, after notice.

* i tessuti sono calcolati senza rapporto / fabrics are calculated without repeat

POLTRONA | ARMCHAIR

volume / volume 0,504 m³
colli / boxes 1

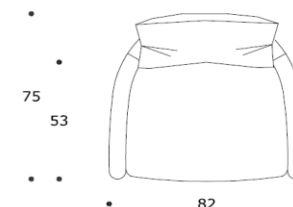
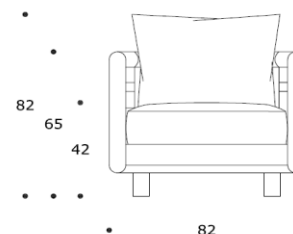
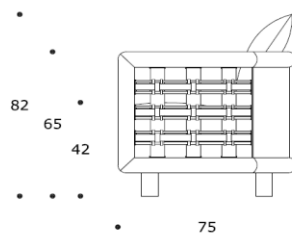

DESCRIZIONE / DESCRIPTION	CODICE / CODE	EURO / EURO
---------------------------	---------------	-------------

poltrona in massello di frassino con dettagli in cuoio intrecciato, schienale e base imbottiti fissi, cuscino di seduta e schienale a densità differenziate e sfoderabili, piedi in legno tinto
solid ash wood armchair with woven hide details, fix padded back and base, seat and back removable cushions with differentiated polyurethane foam densities, tinted wood

PLKILLIA01

tessuto rivestimento
fabric finishing

tessuto cliente ml *6,00 / C.O.M. fabric 1m *6,00
 tessuto cat. B / fabric cat. B
 tessuto cat. C / fabric cat. C
 tessuto cat. D / fabric cat. D
 tessuto cat. E / fabric cat. E
 tessuto cat. F / fabric cat. F
 tessuto cat. G / fabric cat. G
 tessuto cat. LUX / fabric cat. LUX

2.490
2.990
3.155
3.300
3.600
3.910
4.110
5.020

pelle rivestimento
leather finishing

pelle cliente* / C.O.M. leather*
 pelle cat. A / leather cat. A
 pelle cat. B / leather cat. B
 pelle cat. C / leather cat. C
 pelle cat. D / leather cat. D

2.795
2.890
3.200
3.310
3.525

finitura massello di frassino
massive ash finishing

miele / honey
moka / moka

finitura cuoio
hide finishing

sabbia / sand
testa di moro / testa di moro

altre versioni rivestimento
other finishing versions

versione personalizzata tessuto o pelle
personalized version fabric or leather

sovrapprezzo / surcharge

150

optional
optional

piastra girevole
swiveling plate

sovrapprezzo / surcharge

390

N.B. il sovrapprezzo "altre versioni" è da aggiungere al prezzo della categoria di tessuto o pelle seduta scelti
N.B. "other versions" surcharge has to be added to the selected seat fabric or leather category

N.B. rivestimento in tessuto Amelie e Vamp non possibile
N.B. Amelie and Vamp fabric version not available

*TESSUTI E PELLI CLIENTE: La Smania Industria Italiana Mobili S.p.A., si riserva di verificare i materiali forniti dai clienti rispetto alle caratteristiche del prodotto e al tipo di rivestimento richiesto. Qualora questi materiali non siano considerati idonei, la stessa potrà decidere di non procedere con la lavorazione o, nel caso, di abbeditare, previa comunicazione al cliente, un sovrapprezzo. *C.O.M. fabric & C.O.M. leather: Smania Industria Italiana Mobili S.p.A. reserves the right to verify the characteristics of the materials supplied by the customer and also the kind of materials requested. If the materials are not suitable to fit, we may consider not to accept or add an extra charged for possible extra workmanship, after notice.

* i tessuti sono calcolati senza rapporto / fabrics are calculated without repeat

KLIZIA | PLKLIZIA01

POLTRONA | *ARMCHAIR*

volume / volume 0,664 m³
colli / boxes 1

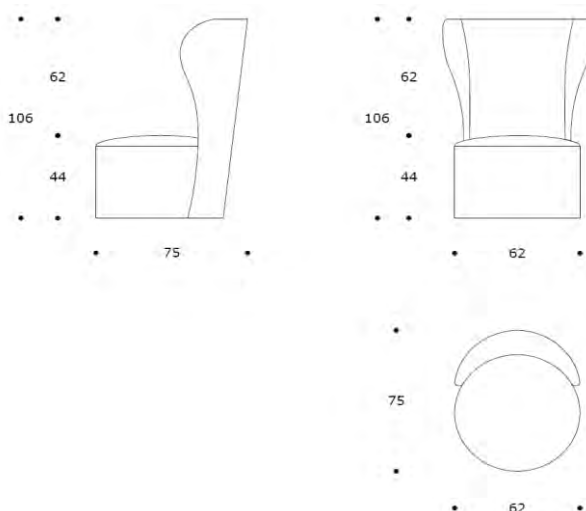

DESCRIZIONE / DESCRIPTION

CODICE / CODE

EURO / EURO

poltrona imbottita fissa a densità differenziata, n.1 cuscino poggiatesta, base girevole
fix padded armchair with differentiated polyurethane foam densities, n.1 kidney pillow, swiveling base

PLKLIZIA01

tessuto rivestimento

fabric finishing

tessuto cliente ml *4,50 / C.O.M. fabric lm *4,50
tessuto cat. B / fabric cat. B
tessuto cat. C / fabric cat. C
tessuto cat. D / fabric cat. D
tessuto cat. E / fabric cat. E
tessuto cat. F / fabric cat. F
tessuto cat. G / fabric cat. G
tessuto cat. LUX / fabric cat. LUX

1.720
2.120
2.245
2.355
2.600
2.840
3.000
3.720

pelle rivestimento

leather finishing

pelle cliente* / C.O.M. leather*
pelle cat. A / leather cat. A
pelle cat. B / leather cat. B
pelle cat. C / leather cat. C
pelle cat. D / leather cat. D

1.915
2.100
2.440
2.555
2.800

N.B. rivestimento in tessuto Amelie e Vamp non possibile

N.B. Amelie and Vamp fabric version not available

*TESSUTI E PELLI CLIENTE: La Smania Industria Italiana Mobili S.p.A., si riserva di verificare i materiali forniti dai clienti rispetto alle caratteristiche del prodotto e al tipo di rivestimento richiesto. Qualora questi materiali non siano considerati idonei, la stessa potrà decidere di non procedere con la lavorazione o, nel caso, di abbeditare, previa comunicazione al cliente, un sovrapprezzo. *C.O.M. fabric & C.O.M. leather: Smania Industria Italiana Mobili S.p.A. reserves the right to verify the characteristics of the materials supplied by the customer and also the kind of materials requested. If the materials are not suitable to fit, we may consider not to accept or add an extra charged for possible extra workmanship, after notice.

* i tessuti sono calcolati senza rapporto / fabrics are calculated without repeat

volume / volume 1,433 m³
colli / boxes 2

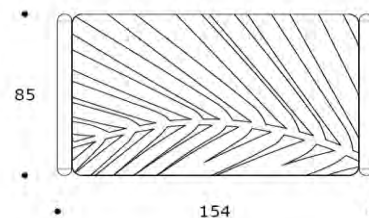
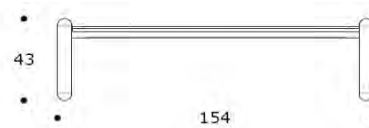
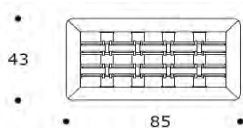

DESCRIZIONE / DESCRIPTION		CODICE / CODE	EURO / EURO
tavolo basso in massello di frassino con particolari in cuoio intrecciato, piano in cristallo temperato bronzo 140x85 cm sp.mm.12 <i>solid ash wood coffee table with woven hide details, bronze tempered glass top 140x85 cm. mm.12 th.</i>		TVHARRIE05	3.250
finitura massello di frassino <i>massive ash finishing</i>	miele / honey moka / moka		
finitura cuoio <i>hide finishing</i>	sabbia / sand testa di moro / testa di moro		
altre finiture piano <i>other top finishings</i>	ceramica "Calce bianco", sp. 12 mm / <i>"Calce bianco" ceramic top, 12 mm th.</i>	sovrapprezzo / surcharge	550
	cristallo "Decoro foglia", sp. 12 mm / <i>"Decoro foglia" tempered glass top, 12 mm th.</i>	sovrapprezzo / surcharge	1.340

HARRIET 130 | TVHARRIE01TAVOLO BASSO | *COFFEE TABLE*

volume / *volume* 1,993 m³
colli / *boxes* 2

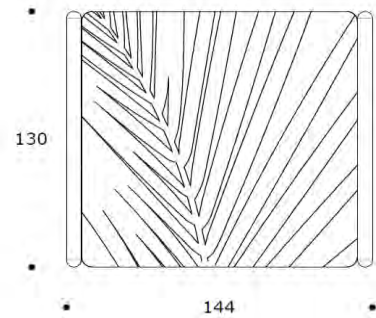
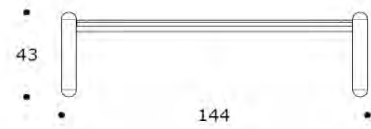
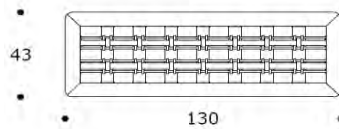
DESCRIZIONE / *DESCRIPTION*CODICE / *CODE*EURO / *EURO*

tavolo basso in massello di frassino con particolari in cuoio intrecciato,
piano in cristallo temperato bronzo 130x130 cm sp.mm.12
*solid ash wood coffee table with woven hide details, bronze tempered glass top
130x130 cm. mm.12 th.*

TVHARRIE01

3.600

**finitura massello di
frassino**

massive ash finishing

miele / *honey*
moka / *moka*

**finitura cuoio
hide finishing**

sabbia / *sand*
testa di moro / *testa di moro*

**altre finiture piano
other top finishings**

ceramica "Calce bianco", sp. 12 mm /
"Calce bianco" ceramic top, 12 mm th.

sovrapprezzo / *surcharge***695**

cristallo "Decoro foglia", sp. 12 mm /
"Decoro foglia" tempered glass top, 12 mm th.

sovrapprezzo / *surcharge***1.360**

TAVOLO BASSO | COFFEE TABLE

volume / volume 0,639 m³
colli / boxes 2

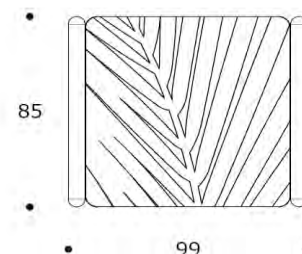
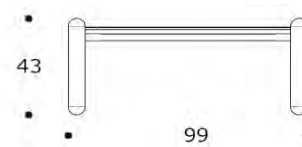
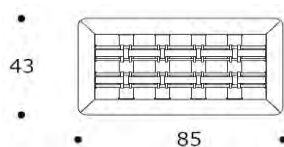

DESCRIZIONE / DESCRIPTION		CODICE / CODE	EURO / EURO
tavolo basso in massello di frassino con particolari in cuoio intrecciato, piano in cristallo temperato bronzo 85x85 cm sp.mm.12 <i>solid ash wood coffee table with woven hide details, bronze tempered glass top 85x85 cm. mm.12 th.</i>		TVHARRIE04	2.200
finitura massello di frassino <i>massive ash finishing</i>	miele / honey moka / moka		
finitura cuoio <i>hide finishing</i>	sabbia / sand testa di moro / testa di moro		
altre finiture piano <i>other top finishings</i>	ceramica "Calce bianco", sp. 12 mm / <i>"Calce bianco" ceramic top, 12 mm th.</i>	sovrapprezzo / surcharge	630
	cristallo "Decoro foglia", sp. 12 mm / <i>"Decoro foglia" tempered glass top, 12 mm th.</i>	sovrapprezzo / surcharge	1.040

ZAREN | TVZAREN01

TAVOLO APPOGGIO | SIDE TABLE

volume / volume 0,434 m³
colli / boxes 2

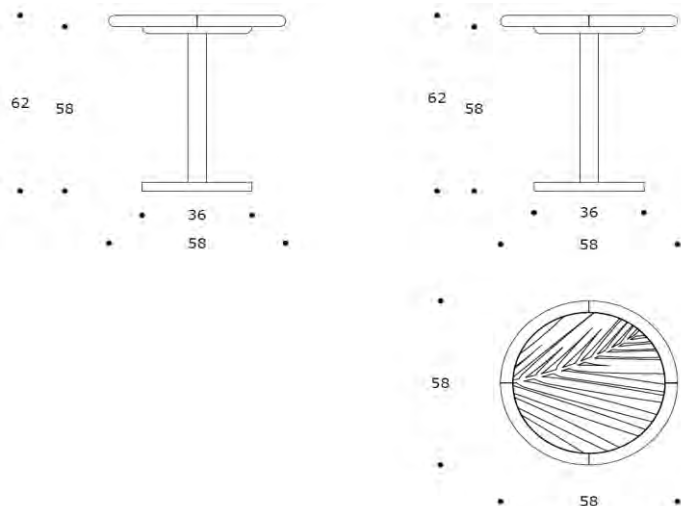

DESCRIZIONE / DESCRIPTION	CODICE / CODE	EURO / EURO
tavolo appoggio in massello di frassino, n.1 piano in cristallo temperato bronzo dia.cm.49,6 sp.mm.12, base in frassino laccato opaco <i>solid ash wood side table, n.1 tempered glass top dia.cm.49,6 mm.12 th., matt lacquered ash base</i>	TVZAREN01	1.400
finitura massello di frassino solid ash wood finishing	miele / honey moka / moka	
altre finiture piano other top finishings	ceramica "Calce bianco", sp. 12 mm / "Calce bianco" ceramic top, 12 mm th.	sovrapprezzo / surcharge 240
	cristallo "Decoro foglia", sp. 12 mm / "Decoro foglia" tempered glass top, 12 mm th.	sovrapprezzo / surcharge 790

CHAMBORD | TVCHAMBO01

TAVOLO PRANZO | DINING TABLE

TAVOLI
TABLES

volume / volume 1,599 m³
colli / boxes 2

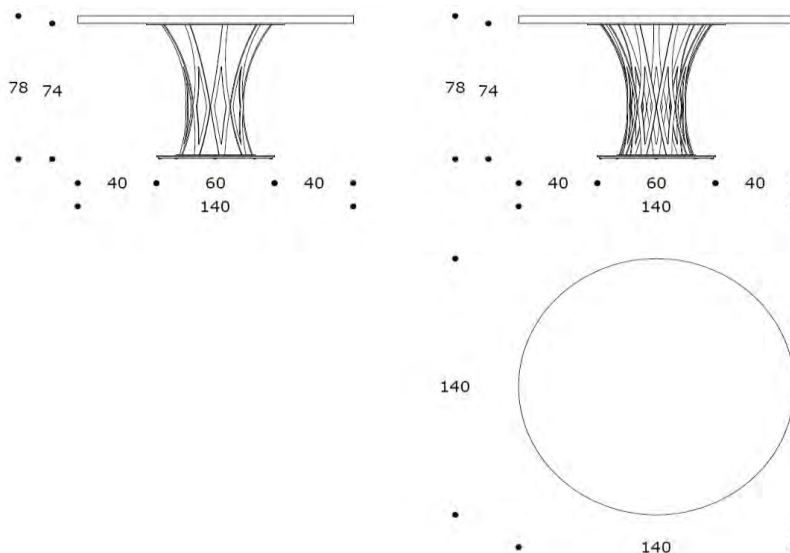

DESCRIZIONE / DESCRIPTION		CODICE / CODE	EURO / EURO
tavolo alto con base in acciaio nichel nero lucido, piano in essenza palissandro opaco o tabacco opaco high table with polished black nickel steel base, matt rosewood or matt tobacco rosewood top		TVCHAMBO01	5.900
altre finiture piano other top finishings	palissandro lucido / polish rosewood palissandro tabacco lucido / polish tobacco rosewood piuma di noce / burr walnut piuma di noce grigia / grey burr walnut lacca lucida / polish lacquer	sovrapprezzo / surcharge sovrapprezzo / surcharge sovrapprezzo / surcharge sovrapprezzo / surcharge sovrapprezzo / surcharge	1.575 1.575 150 160 1.520
	marmo "nero marquinia" sp.mm.20 / "nero marquinia" marble 20 mm th marmo "emperador dark" sp.mm.20 "emperador dark" marble 20 mm th marmo "silver wave" sp.mm.20 "silver wave" marble 20 mm th marmo "calacatta gold" sp.mm.20 "calacatta gold" marble 20 mm th marmo "calacatta cielo" sp.mm.20 "calacatta cielo" marble 20 mm th marmo "azul macaubas" sp.mm.20 "azul macaubas" marble 20 mm th	sovrapprezzo / surcharge sovrapprezzo / surcharge sovrapprezzo / surcharge sovrapprezzo / surcharge sovrapprezzo / surcharge sovrapprezzo / surcharge	2.560 2.560 4.265 4.820 6.025 6.340
altre finitura base other base finishing	acciaio / stainless steel oro rosa / gold rose	sovrapprezzo / surcharge sovrapprezzo / surcharge	270 270

FLINT 240 | TVFLINT01

TAVOLO ALTO | HIGH TABLE

volume / volume 2,427 m³
colli / boxes 2

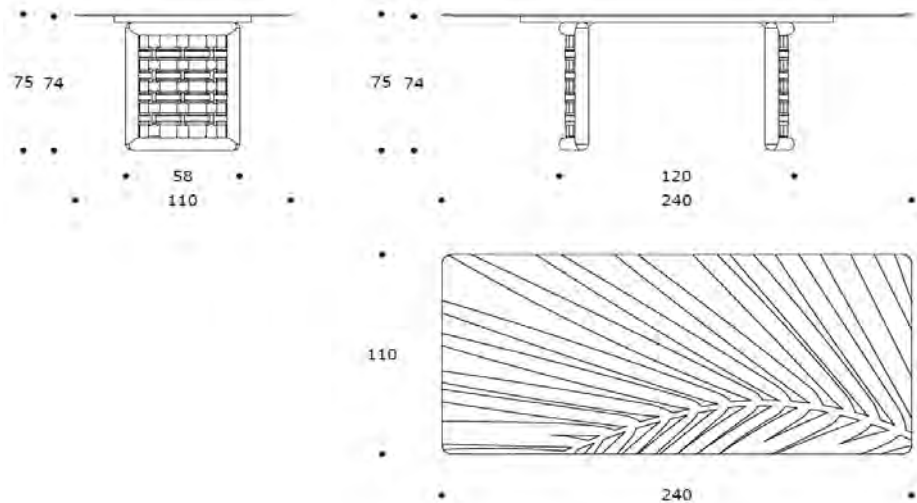

DESCRIZIONE / DESCRIPTION

CODICE / CODE

EURO / EURO

tavolo alto rettangolare in massello di frassino con particolari in cuoio intrecciato,
piano in cristallo temperato bronzo 240x110 cm sp.mm.12
*solid ash wood rectangular high table with woven hide details, bronze tempered
glass top 240x110 cm. mm.12 th.*

TVFLINT01

4.750

**finitura massello di
frassino
solid ash wood
finishing**

miele / honey
moka / moka

**altre finiture piano
other top finishings**

cristallo "Decoro foglia", sp. 12 mm /
"Decoro foglia" tempered glass top, 12 mm th.

sovrapprezzo / surcharge

2.180

FLINT 200 | TVFLINT03

TAVOLO ALTO | HIGH TABLE

volume / volume 2,184 m³
colli / boxes 2

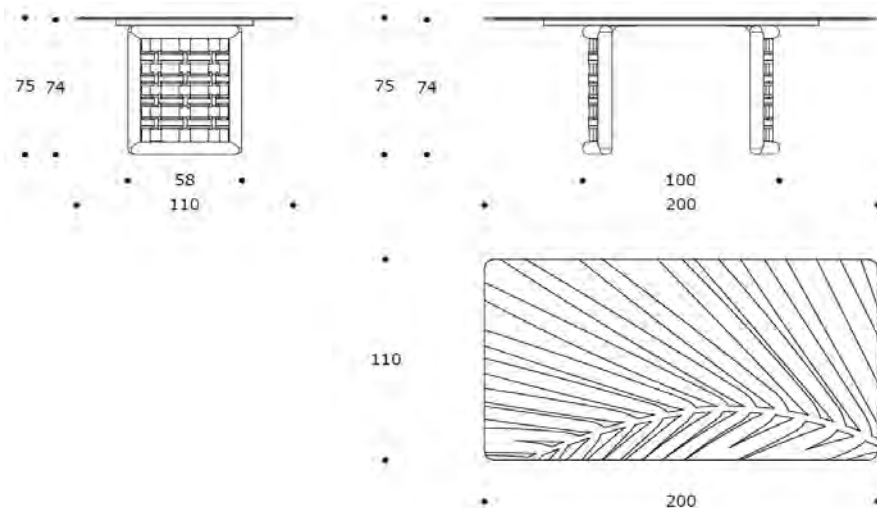

DESCRIZIONE / DESCRIPTION	CODICE / CODE	EURO / EURO
<p>tavolo alto rettangolare in massello di frassino con particolari in cuoio intrecciato, piano in cristallo temperato bronzo 200x110 cm sp.mm.12 <i>solid ash wood rectangular high table with woven hide details, bronze tempered glass top 200x110 cm. mm.12 th.</i></p> <p>finitura massello di frassino solid ash wood finishing</p> <p>miele / honey moka / moka</p> <p>altre finiture piano other top finishings</p> <p>cristallo "Decoro foglia", sp. 12 mm / <i>"Decoro foglia" tempered glass top, 12 mm th.</i></p>	<p>TVFLINT03</p> <p>sovrapprezzo / surcharge</p>	<p>4.600</p> <p>1.760</p>

FLINT 160 | TVFLINT02

TAVOLO ALTO | HIGH TABLE

volume / volume 2,327 m³
colli / boxes 2

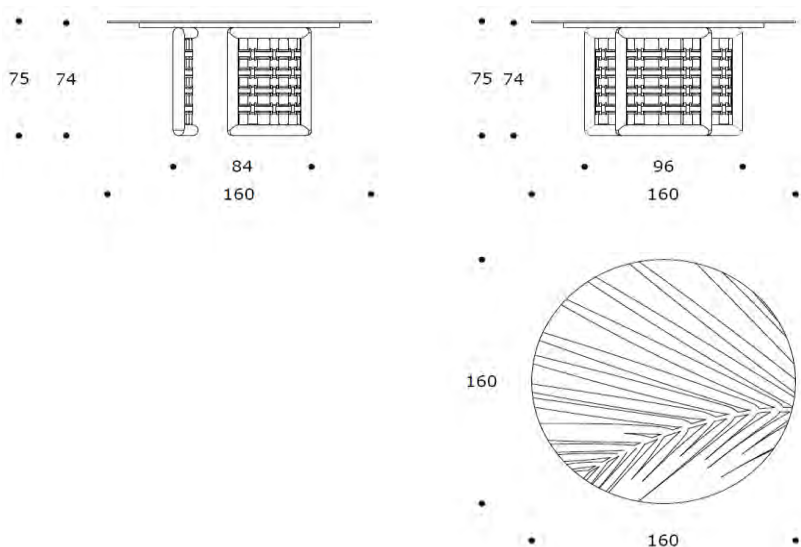

DESCRIZIONE / DESCRIPTION	CODICE / CODE	EURO / EURO
<p>tavolo alto rotondo in massello di frassino con particolari in cuoio intrecciato, piano in cristallo temperato bronzo dia.160 cm sp.mm.12 <i>solid ash wood round high table with woven hide details, bronze tempered glass top dia.160 cms mm.12 th.</i></p>	TVFLINT02	6.300
<p>finitura massello di frassino solid ash wood finishing</p> <p>miele / honey moka / moka</p>		
<p>altre finiture piano other top finishings</p> <p>cristallo "Decoro foglia", sp. 12 mm / <i>"Decoro foglia" tempered glass top, 12 mm th.</i></p>	sovrapprezzo / surcharge	2.120

volume / volume 0,359 m³
colli / boxes 1

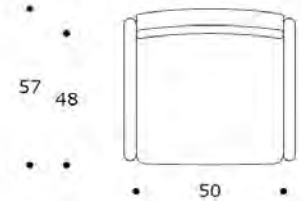
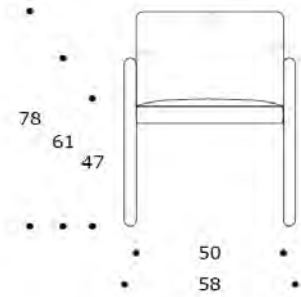
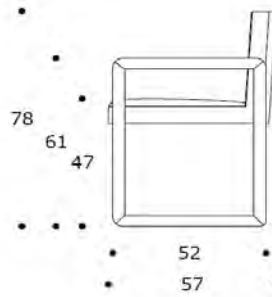

DESCRIZIONE / DESCRIPTION		CODICE / CODE	EURO / EURO
sedia imbottita fissa a densità differenziate, braccioli e gambe in massello di frassino <i>fix padded chair with differentiated polyurethane foam densities, solid ash wood legs</i>		SDANTILLIO1	
tessuto rivestimento <i>fabric finishing</i>	tessuto cliente ml *2,50 / C.O.M. fabric lm *2,50		975
	tessuto cat. B / fabric cat. B		1.155
	tessuto cat. C / fabric cat. C		1.215
	tessuto cat. D / fabric cat. D		1.265
	tessuto cat. E / fabric cat. E		1.375
	tessuto cat. F / fabric cat. F		1.485
	tessuto cat. G / fabric cat. G		1.560
	tessuto cat. LUX / fabric cat. LUX		1.885
pelle rivestimento <i>leather finishing</i>	pelle cliente* / C.O.M. leather*		1.075
	pelle cat. A / leather cat. A		1.120
	pelle cat. B / leather cat. B		1.250
	pelle cat. C / leather cat. C		1.295
	pelle cat. D / leather cat. D		1.385

finitura massiccio di frassino
solid ash wood finishing

miele / honey
moka / moka

N.B. rivestimento in tessuto Amelie e Vamp non possibile
N.B. Amelie and Vamp fabric version not available

*TESSUTI E PELLI CLIENTE: La Smania Industria Italiana Mobili S.p.A., si riserva di verificare i materiali forniti dai clienti rispetto alle caratteristiche del prodotto e al tipo di rivestimento richiesto. Qualora questi materiali non siano considerati idonei, la stessa potrà decidere di non procedere con la lavorazione o, nel caso, di abbeditare, previa comunicazione al cliente, un sovrapprezzo.

*C.O.M. fabric & C.O.M. leather: Smania Industria Italiana Mobili S.p.A. reserves the right to verify the characteristics of the materials supplied by the customer and also the kind of materials requested. If the materials are not suitable to fit, we may consider not to accept or add an extra charged for possible extra workmanship, after notice.

* i tessuti sono calcolati senza rapporto / fabrics are calculated without repeat

SEDIA | CHAIR

volume / volume 0,268 m³
 colli / boxes 1

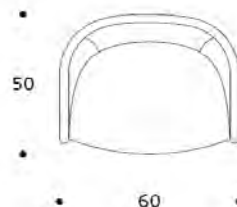
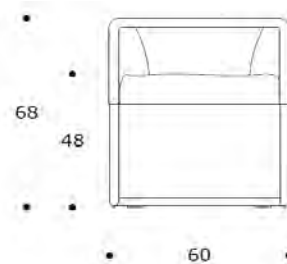
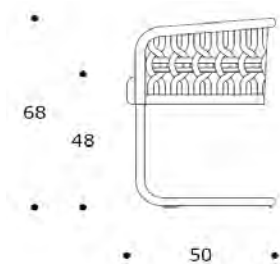

DESCRIZIONE / DESCRIPTION	CODICE / CODE	EURO / EURO
---------------------------	---------------	-------------

sedia imbottita fissa a densità differenziate, particolari in cuoio intrecciato, base in acciaio
 nichel nero lucido o spazzolato
*fix padded chair with differentiated foam densities, woven hide details, polished black
 nickel or brushed steel base*

SDELLEN01

tessuto rivestimento
fabric finishing

tessuto cliente ml *2,10 / C.O.M. fabric lm *2,10	1.580
tessuto cat. B / fabric cat. B	1.735
tessuto cat. C / fabric cat. C	1.795
tessuto cat. D / fabric cat. D	1.845
tessuto cat. E / fabric cat. E	1.955
tessuto cat. F / fabric cat. F	2.065
tessuto cat. G / fabric cat. G	2.135
tessuto cat. LUX / fabric cat. LUX	2.480

pelle rivestimento
leather finishing

pelle cliente* / C.O.M. leather*	1.740
pelle cat. A / leather cat. A	1.780
pelle cat. B / leather cat. B	1.950
pelle cat. C / leather cat. C	2.020
pelle cat. D / leather cat. D	2.145

finiture cuoio
hide finishing

sabbia / sand
 testa di moro / testa di moro

finitura base
base finishing

acciaio / stainless steel	sovrapprezzo / surcharge	60
oro rosa / gold rose	sovrapprezzo / surcharge	60
brunito spazzolato / brushed bronzed	sovrapprezzo / surcharge	100
nichel spazzolato / brushed nickel	sovrapprezzo / surcharge	120

N.B. rivestimento in tessuto Amelie e Vamp non possibile
N.B. Amelie and Vamp fabric version not available

*TESSUTE E PELLI CLIENTE: La Smania Industria Italiana Mobili S.p.A., si riserva di verificare i materiali forniti dai clienti rispetto alle caratteristiche del prodotto e al tipo di rivestimento richiesto. Qualora questi materiali non siano considerati idonei, la stessa potrà decidere di non procedere con la lavorazione o, nel caso, di abbeditare, previa comunicazione al cliente, un sovrapprezzo.

*C.O.M. fabric & C.O.M. leather: Smania Industria Italiana Mobili S.p.A. reserves the right to verify the characteristics of the materials supplied by the customer and also the kind of materials requested. If the materials are not suitable to fit, we may consider not to accept or add an extra charged for possible extra workmanship, after notice.

* i tessuti sono calcolati senza rapporto / fabrics are calculated without repeat

volume / volume 0,339 m³
colli / boxes 1

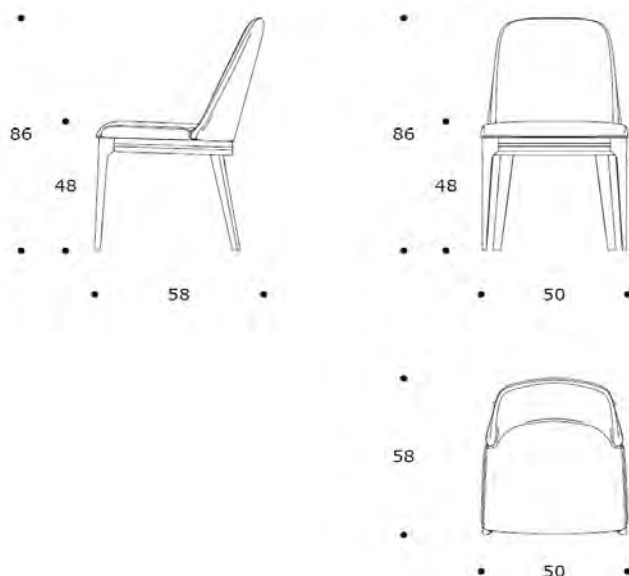

DESCRIZIONE / DESCRIPTION		CODICE / CODE	EURO / EURO
<p>sedia imbottita fissa, gambe in legno di faggio tinto wengè - palissandro tabacco opaco, dettaglio effetto spazzolato o lucido <i>fix padded chair, wengè - matt tobacco rosewood tinted beech wood legs, brushed or polish effect detail</i></p>		SDINES01	
altre finiture struttura <i>other structure finishings</i>	<p>palissandro opaco / <i>matt rosewood</i> palissandro lucido / <i>polish rosewood</i> palissandro tabacco lucido / <i>polish tobacco rosewood</i> noce / <i>walnut</i> noce grigia / <i>grey walnut</i> noce canaletto opaco / <i>matt canaletto walnut</i> noce canaletto lucido / <i>polish canaletto walnut</i></p>	<p>sovrapprezzo / <i>surcharge</i> sovrapprezzo / <i>surcharge</i> sovrapprezzo / <i>surcharge</i> sovrapprezzo / <i>surcharge</i> sovrapprezzo / <i>surcharge</i> sovrapprezzo / <i>surcharge</i> sovrapprezzo / <i>surcharge</i></p>	<p>60 115 115 60 60 60 115</p>
tessuto rivestimento <i>fabric finishing</i>	<p>tessuto cliente ml *1,50 / <i>C.O.M. fabric 1m *1,50</i> tessuto cat. B / <i>fabric cat. B</i> tessuto cat. C / <i>fabric cat. C</i> tessuto cat. D / <i>fabric cat. D</i> tessuto cat. E / <i>fabric cat. E</i> tessuto cat. F / <i>fabric cat. F</i> tessuto cat. G / <i>fabric cat. G</i> tessuto cat. LUX / <i>fabric cat. LUX</i></p>		<p>660 815 855 885 955 1.025 1.075 1.280</p>
pelle rivestimento <i>leather finishing</i>	<p>pelle cliente* / <i>C.O.M. leather*</i> pelle cat. A / <i>leather cat. A</i> pelle cat. B / <i>leather cat. B</i> pelle cat. C / <i>leather cat. C</i> pelle cat. D / <i>leather cat. D</i></p>		<p>780 850 985 1.035 1.140</p>
finiture profilo <i>detail finishings</i>	<p>nichel spazzolato / <i>brushed nickel</i> brunito spazzolato / <i>brushed bronzed</i> acciaio lucido / <i>polished steel</i> nichel nero lucido / <i>polished black nickel</i></p>		

N.B. rivestimento in tessuto Amelie e Vamp non possibile
N.B. Amelie and Vamp fabric version not available

*TESSUTI E PELLI CLIENTE: La Smania Industria Italiana Mobili S.p.A., si riserva di verificare i materiali forniti dai clienti rispetto alle caratteristiche del prodotto e al tipo di rivestimento richiesto. Qualora questi materiali non siano considerati idonei, la stessa potrà decidere di non procedere con la lavorazione o, nel caso, di abbeditare, previa comunicazione al cliente, un sovrapprezzo.

*C.O.M. fabric & C.O.M. leather: Smania Industria Italiana Mobili S.p.A. reserves the right to verify the characteristics of the materials supplied by the customer and also the kind of materials requested. If the materials are not suitable to fit, we may consider not to accept or add an extra charged for possible extra workmanship, after notice.

* i tessuti sono calcolati senza rapporto / *fabrics are calculated without repeat*



volume / *volume* 0,000 m³
colli / *boxes* 2

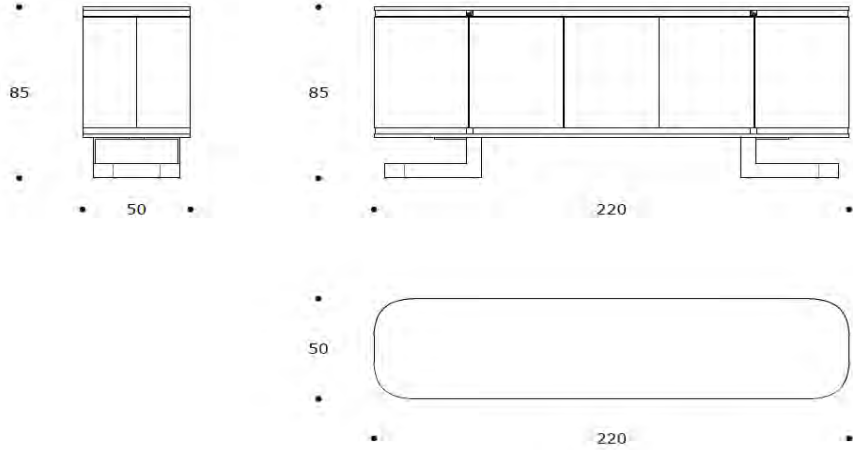

DESCRIZIONE / <i>DESCRIPTION</i>		CODICE / <i>CODE</i>	EURO / <i>EURO</i>
credenza in essenza palissandro opaco o tabacco opaco, 2 ante in pelle, 3 ante in essenza, 1 cassetto, 4 ripiani, gambe e dettagli in acciaio brunito spazzolato <i>matt rosewood or matt tobacco rosewood sideboard, 2 leather doors, 3 wooden doors, 1 drawer, 4 shelves, brushed bronzed steel legs and details</i>		CRANITHA01	
pelle rivestimento <i>leather finishing</i>			
	pelle cliente* / <i>C.O.M. leather*</i>		11.150
	pelle cat. A-B-C-D / <i>leather cat. A-B-C-D</i>		11.400
altre finiture struttura <i>other structure finishings</i>			
	palissandro lucido / <i>polish rosewood</i>	sovrapprezzo / <i>surcharge</i>	2.500
	palissandro tabacco lucido / <i>polish tobacco rosewood</i>	sovrapprezzo / <i>surcharge</i>	2.500
	piuma di noce e noce / <i>burr walnut and walnut</i>	sovrapprezzo / <i>surcharge</i>	955
	piuma di noce e noce grigia / <i>grey burr walnut and walnut</i>	sovrapprezzo / <i>surcharge</i>	1.135
	lacca lucida / <i>polish lacquer</i>	sovrapprezzo / <i>surcharge</i>	2.375
finiture acciaio <i>steel finishings</i>			
	nicel spazzolato / <i>brushed nickel</i>	sovrapprezzo / <i>surcharge</i>	400

*PELLI CLIENTE: La Smania Industria Italiana Mobili S.p.A., si riserva di verificare i materiali forniti dai clienti rispetto alle caratteristiche del prodotto e al tipo di rivestimento richiesto. Qualora questi materiali non siano considerati idonei, la stessa potrà decidere di non procedere con la lavorazione o, nel caso, di abbeditare, previa comunicazione al cliente, un sovrapprezzo.
 *C.O.M. leather: Smania Industria Italiana Mobili S.p.A. reserves the right to verify the characteristics of the materials supplied by the customer and also the kind of materials requested. If the materials are not suitable to fit, we may consider not to accept or add an extra charged for possible extra workmanship, after notice.

CASSIDY 280 | CRCASSID01

MOBILE CONTENITORE | CABINET

volume / volume 1,111 m³
colli / boxes 2

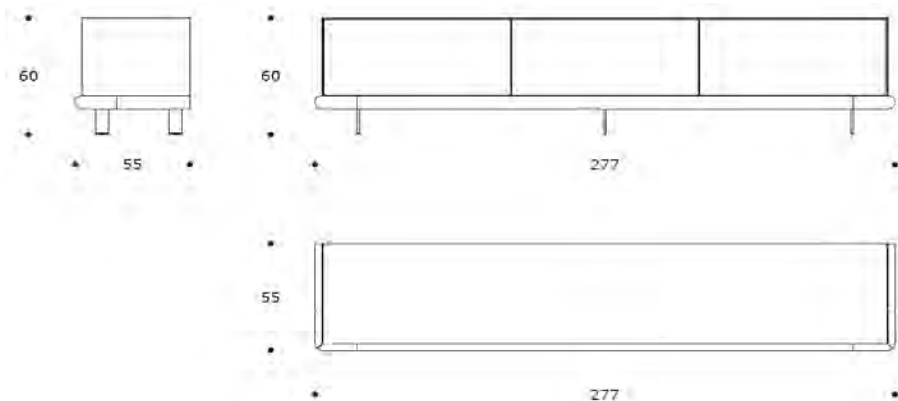

DESCRIZIONE / DESCRIPTION		CODICE / CODE	EURO / EURO
mobile contenitore in essenza di frassino laccato opaco, 3 cestoni, profili in massello di frassino, piedi in acciaio laccato opaco <i>matt lacquered ash wood cabinet, 3 jumbo drawers, solid ash wood details, matt lacquer steel legs</i>		CRCASSID01	4.600
finiture struttura structure finishings	beige / beige blu / blue bordeaux / bordeaux grigio / grey grigio seta / silk grey verde / green		
finitura massiccio di frassino solid ash wood finishing	miele / honey moka / moka		

CASSIDY 190 | CRCASSID02

MOBILE CONTENITORE | CABINET

volume / volume 0,761 m³
colli / boxes 2

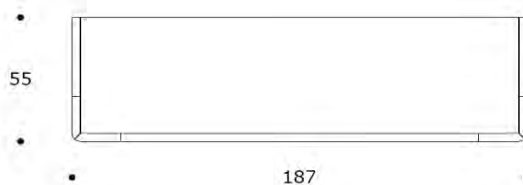
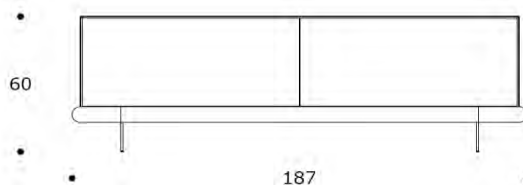
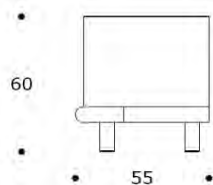

DESCRIZIONE / DESCRIPTION	CODICE / CODE	EURO / EURO
<p>mobile contenitore in essenza di frassino laccato opaco, 2 cestoni, profili in massello di frassino, piedi in acciaio laccato opaco <i>matt lacquered ash wood cabinet, 2 jumbo drawers, solid ash wood details, matt lacquer steel legs</i></p> <p>finiture struttura structure finishings</p> <p>beige / beige blu / blue bordeaux / bordeaux grigio / grey grigio seta / silk grey verde / green</p>	CRCASSID02	3.950
<p>finitura massiccio di frassino solid ash wood finishing</p> <p>miele / honey moka / moka</p>		

CASSIDY 207 HIGH | CRCASSID03

CREDENZA | CABINET

volume / volume 0,000 m³
colli / boxes 2

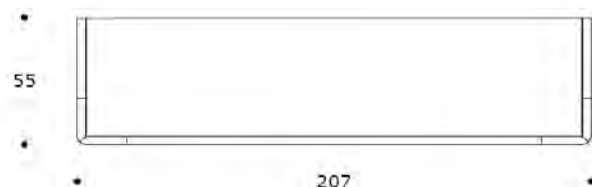
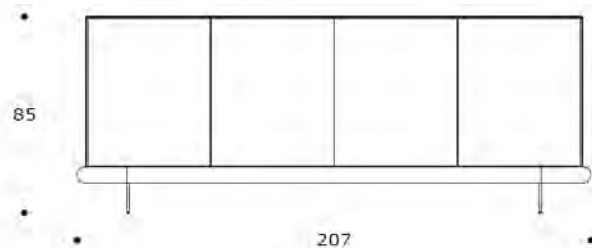
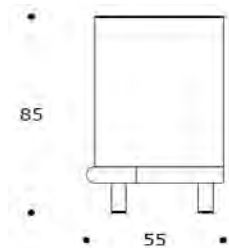

DESCRIZIONE / DESCRIPTION

CODICE / CODE

EURO / EURO

credenza in essenza di frassino laccato opaco, 4 ante, 2 cassetti, profili in massello di frassino, piedi in acciaio laccato opaco
matt lacquered ash wood sideboard, 4 doors, 2 drawers, solid ash wood details, matt lacquer steel legs

CRCASSID03

4.545

finiture struttura
structure finishings

beige / beige
blu / blue
bordeaux / bordeaux
grigio / grey
grigio seta / silk grey
verde / green

finitura massiccio di frassino
solid ash wood finishing

miele / honey
moka / moka

volume / *volume* 1,352 m³
colli / *boxes* 2

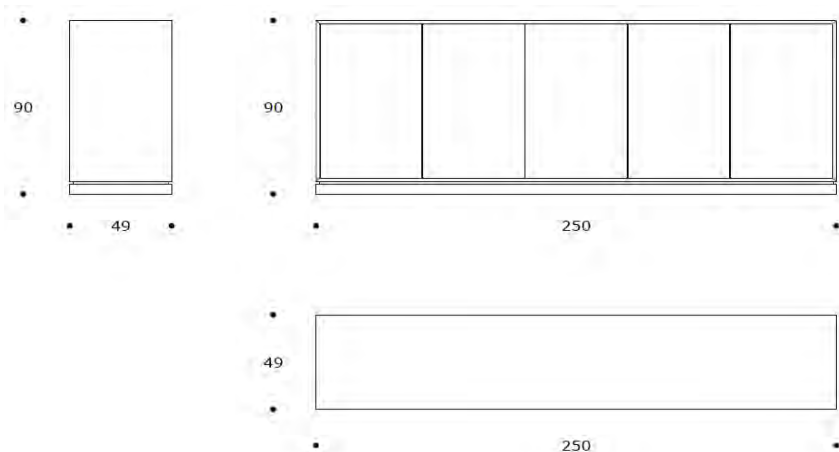

DESCRIZIONE / <i>DESCRIPTION</i>	CODICE / <i>CODE</i>	EURO / <i>EURO</i>
credenza in essenza palissandro opaco o tabacco opaco, 5 ante, 2 cassetti, 3 ripiani <i>matt rosewood or matt tobacco rosewood sideboard, 5 doors, 2 drawers, 3 shelves</i>	CRTWEED01	7.760
altre finiture struttura <i>other structure</i> <i>finishings</i>		
palissandro lucido / <i>polish rosewood</i>	sovrapprezzo / <i>surcharge</i>	3.000
palissandro tabacco lucido / <i>polish tobacco rosewood</i>	sovrapprezzo / <i>surcharge</i>	3.000
piuma di noce e noce / <i>burr walnut and walnut</i>	sovrapprezzo / <i>surcharge</i>	1.050
piuma di noce e noce grigia / <i>grey burr walnut and walnut</i>	sovrapprezzo / <i>surcharge</i>	1.170
lacca lucida / <i>polish lacquer</i>	sovrapprezzo / <i>surcharge</i>	2.850



volume / volume 1,466 m³
colli / boxes 1

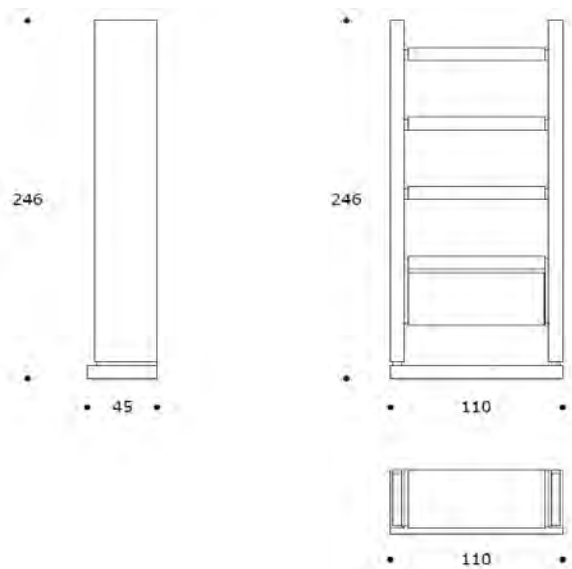

DESCRIZIONE / DESCRIPTION	CODICE / CODE	EURO / EURO
colonna libreria in essenza palissandro opaco o tabacco opaco, 1 cestone, 4 ripiani, dettagli in acciaio effetto satinato opaco <i>matt rosewood or matt tobacco rosewood bookcase column, 1 jumbo drawer, 4 shelves, matt glazed effect steel details</i>	LBLUDWIG01	7.730
altre finiture other finishings		
palissandro lucido / <i>polish rosewood</i>	sovrapprezzo / <i>surcharge</i>	2.500
palissandro tabacco lucido / <i>polish tobacco rosewood</i>	sovrapprezzo / <i>surcharge</i>	2.500
piuma di noce e noce / <i>burr walnut and walnut</i>	sovrapprezzo / <i>surcharge</i>	480
piuma di noce e noce grigia / <i>grey burr walnut and w</i>	sovrapprezzo / <i>surcharge</i>	745
eucalipto frisè grigio opaco / <i>matt grey frisè eucalypt</i>	sovrapprezzo / <i>surcharge</i>	550
eucalipto frisè grigio lucido / <i>polish grey frisè eucalypt</i>	sovrapprezzo / <i>surcharge</i>	2.850
finiture acciaio steel finishings		
ghiaccio / <i>ice</i>		
miele / <i>honey</i>		

VETRINETTA | CABINET

volume / volume 1,187 m³
colli / boxes 3

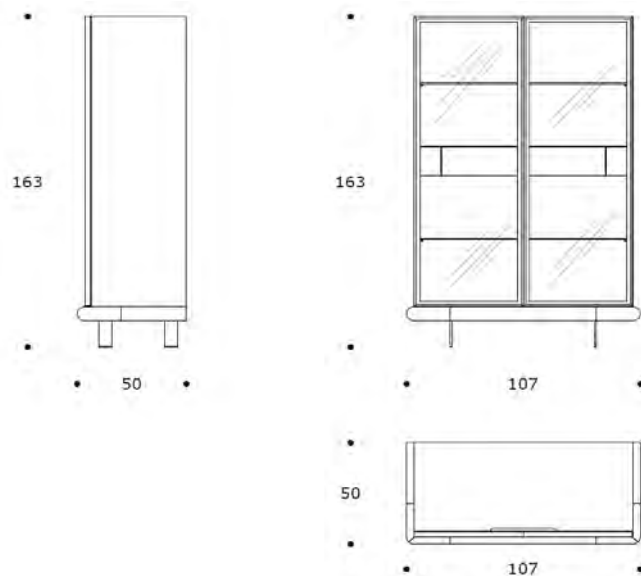

DESCRIZIONE / DESCRIPTION	CODICE / CODE	EURO / EURO
<p>vetrinetta in essenza di frassino laccato opaco, ante in alluminio verniciato titanio e vetro bronzato, 3 ripiani in vetro bronzato, 1 cassetto in pelle, illuminazione interna, profilo in massello di frassino, piedi in acciaio laccato opaco <i>matt lacquered ash wood cabinet, titanium lacquered aluminium doors with bronzed glass, 3 bronzed glass shelves, 1 leather drawe, internal lighting, solid ash wood detail, matt lacquered steel legs</i></p> <p>finiture struttura structure finishings</p> <p>beige / beige blu / blue bordeaux / bordeaux grigio / grey grigio seta / silk grey verde / green</p> <p>finitura massiccio di frassino massive ash finishing</p> <p>miele / honey moka / moka</p>	LBMERA01	6.500
<p>altre finiture schiena other back finishing</p> <p>pelle cliente* / C.O.M. leather* pelle cat. A-B-C-D / leather cat. A-B-C-D</p> <p>"Decoro foglia" / "Decoro foglia"</p>	<p>sovrapprezzo / surcharge</p> <p>sovrapprezzo / surcharge</p> <p>sovrapprezzo / surcharge</p>	<p>300</p> <p>500</p> <p>1.300</p>

*PELLI CLIENTE: La Smania Industria Italiana Mobili S.p.A., si riserva di verificare i materiali forniti dai clienti rispetto alle caratteristiche del prodotto e al tipo di rivestimento richiesto. Qualora questi materiali non siano considerati idonei, la stessa potrà decidere di non procedere con la lavorazione o, nel caso, di abbeditare, previa comunicazione al cliente, un sovrapprezzo.

*C.O.M. leather: Smania Industria Italiana Mobili S.p.A. reserves the right to verify the characteristics of the materials supplied by the customer and also the kind of materials requested. If the materials are not suitable to fit, we may consider not to accept or add an extra charged for possible extra workmanship, after notice.

volume / volume 2,133 m³
colli / boxes 3

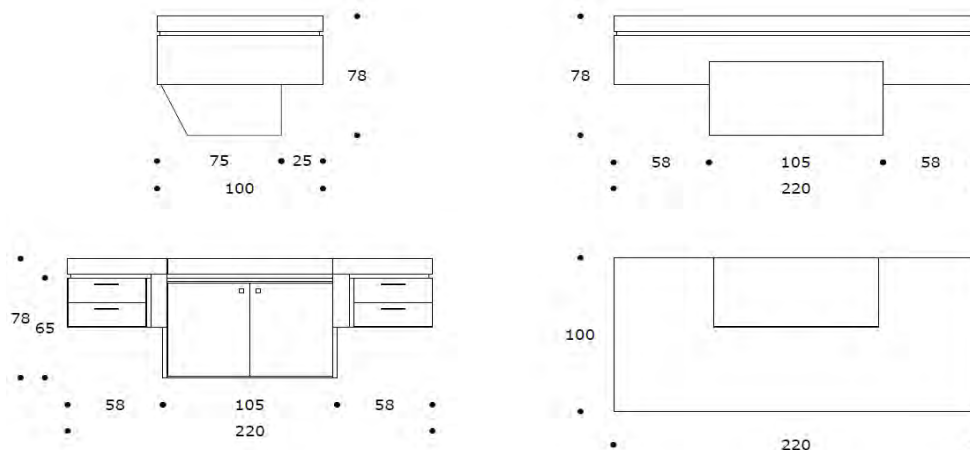

DESCRIZIONE / DESCRIPTION	CODICE / CODE	EURO / EURO
scrivania in essenza palissandro opaco o tabacco opaco, 4 cassetti, piano estraibile in pelle o "MicroNabuk", dettagli in acciaio effetto satinato opaco <i>matt rosewood or matt tobacco rosewood desk, 4 drawers, extractable top in leather or "MicroNabuk" finish, glazed effect steel details</i>	SCFRANK01	
rivestimento piano estraibile extractable top finishing		
"MicroNabuk" / "MicroNabuk"		10.855
pelle cliente* / C.O.M. leather*		10.950
pelle cat. A-B-C-D / leather cat. A-B-C-D		11.100
altre finiture other finishings		
palissandro lucido / polish rosewood	sovrapprezzo / surcharge	5.700
palissandro tabacco lucido / polish tobacco rosewood	sovrapprezzo / surcharge	5.700
piuma di noce e noce / burr walnut and walnut	sovrapprezzo / surcharge	955
piuma di noce e noce grigia / grey burr walnut and w	sovrapprezzo / surcharge	1.135
eucalipto frisé grigio opaco / matt grey frisé eucalypt	sovrapprezzo / surcharge	1.100
eucalipto frisé grigio lucido / polish grey frisé eucalypt	sovrapprezzo / surcharge	5.900
finiture acciaio steel finishings		
ghiaccio effetto satinato / ice glazed effect		
miele effetto satinato / honey glazed effect		

*PELLI CLIENTE: La Smania Industria Italiana Mobili S.p.A., si riserva di verificare i materiali forniti dai clienti rispetto alle caratteristiche del prodotto e al tipo di rivestimento richiesto. Qualora questi materiali non siano considerati idonei, la stessa potrà decidere di non procedere con la lavorazione o, nel caso, di abbeditare, previa comunicazione al cliente, un sovrapprezzo.
*C.O.M. leather: Smania Industria Italiana Mobili S.p.A. reserves the right to verify the characteristics of the materials supplied by the customer and also the kind of materials requested. If the materials are not suitable to fit, we may consider not to accept or add an extra charged for possible extra workmanship, after notice.



volume / volume 0,900 m³
colli / boxes 1

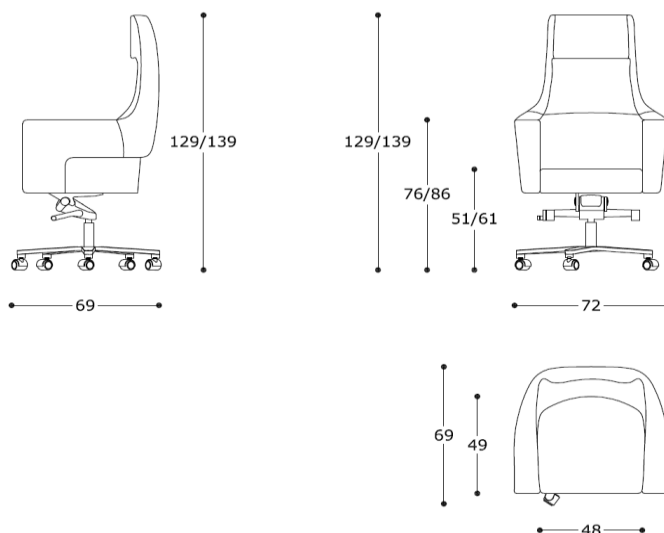

DESCRIZIONE / DESCRIPTION	CODICE / CODE	EURO / EURO
<p>poltrona direzionale girevole imbottita fissa, meccanismo oscillante e regolabile, base inox con ruote <i>fix padded swiveling executive armchair, swinging and adjustable mechanism, stainless steel base with castors</i></p>	PLCAREY01	
<p>rivestimento finishing</p> <p>“MicroNabuk” / “MicroNabuk”</p> <p>pelle cliente* / <i>C.O.M. leather*</i> pelle cat. A / <i>leather cat. A</i> pelle cat. B / <i>leather cat. B</i> pelle cat. C / <i>leather cat. C</i> pelle cat. D / <i>leather cat. D</i></p>		<p>1.990</p> <p>1.950 2.215 2.460 2.560 2.740</p>
<p>optional optional</p> <p>stampa cavallo “Troy” a rilievo solo su cuscino poggiatesta in pelle liscia <i>“Troy” horse relief printing only on plain leather head rest cushion</i></p>	sovrapprezzo / surcharge	60

*PELLI CLIENTE: La Smania Industria Italiana Mobili S.p.A. si riserva di verificare i materiali forniti dai clienti rispetto alle caratteristiche del prodotto e al tipo di rivestimento richiesto. Qualora questi materiali non siano considerati idonei, la stessa potrà decidere di non procedere con la lavorazione o, nel caso, di addebitare, previa comunicazione al cliente, un sovrapprezzo.
 *C.O.M. leather: Smania Industria Italiana Mobili S.p.A reserves the right to verify the characteristics of the materials supplied by the customer and also the kind of materials requested. If the materials are not suitable to fit, we may consider not to accept or add an extra charge for possible extra workmanship, after notice.

CAREY | PLCAREY02

POLTRONA BASSA | *LOW ARMCHAIR*

volume / *volume* 0,698 m³
colli / *boxes* 1

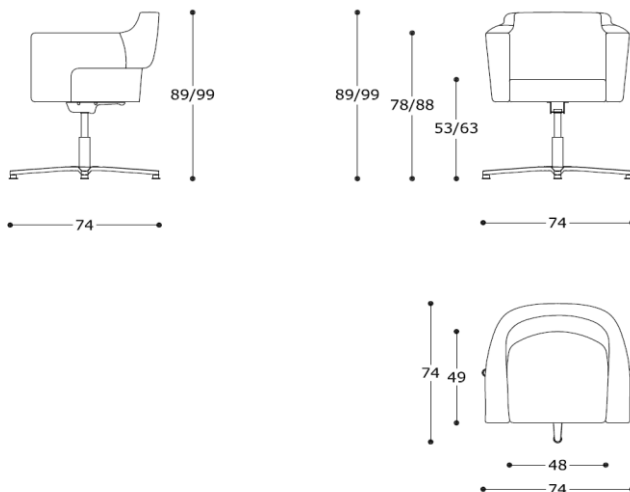

DESCRIZIONE / *DESCRIPTION*

CODICE / *CODE*

EURO / *EURO*

poltrona bassa girevole imbottita fissa, base inox con piedini
fix padded low swiveling armchair, stainless steel base with feet

PLCAREY02

rivestimento
finishing

“MicroNabuk” / “*MicroNabuk*”

1.690

pelle cliente* / *C.O.M. leather**

1.565

pelle cat. A / *leather cat. A*

2.060

pelle cat. B / *leather cat. B*

2.290

pelle cat. C / *leather cat. C*

2.380

pelle cat. D / *leather cat. D*

2.545

*PELLI CLIENTE: La Smania Industria Italiana Mobili S.p.A. si riserva di verificare i materiali forniti dai clienti rispetto alle caratteristiche del prodotto e al tipo di rivestimento richiesto. Qualora questi materiali non siano considerati idonei, la stessa potrà decidere di non procedere con la lavorazione o, nel caso, di addebitare, previa comunicazione al cliente, un sovrapprezzo.

*C.O.M. leather: Smania Industria Italiana Mobili S.p.A reserves the right to verify the characteristics of the materials supplied by the customer and also the kind of materials requested. If the materials are not suitable to fit, we may consider not to accept or add an extra charge for possible extra workmanship, after notice.

volume / volume 0,865 m³
colli / boxes 1

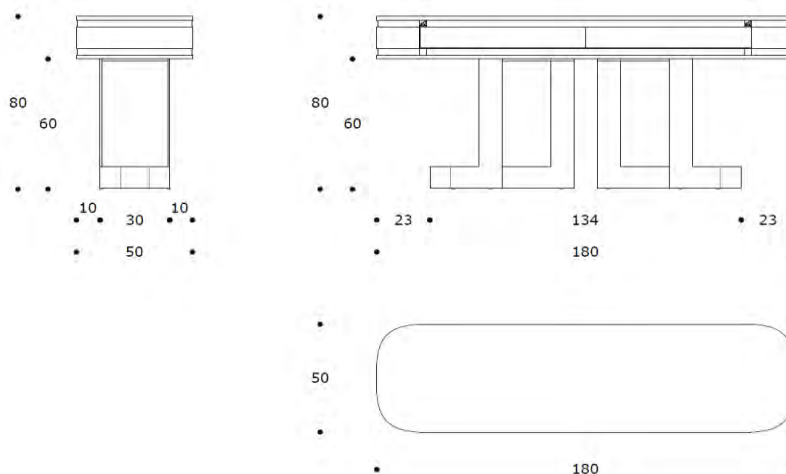

DESCRIZIONE / DESCRIPTION	CODICE / CODE	EURO / EURO
consolle in essenza palissandro opaco o tabacco opaco, 2 cassetti, dettagli in acciaio brunito spazzolato <i>matt rosewood or matt tobacco rosewood console, 2 drawers, brushed bronzed steel details</i>	CSBRIGIT01	8.120
altre finiture other finishings		
palissandro lucido / <i>polish rosewood</i>	sovrapprezzo / <i>surcharge</i>	1.250
palissandro tabacco lucido / <i>polish tobacco rosewood</i>	sovrapprezzo / <i>surcharge</i>	1.250
piuma di noce e noce / <i>burr walnut and walnut</i>	sovrapprezzo / <i>surcharge</i>	200
piuma di noce e noce grigia / <i>grey burr walnut and w</i>	sovrapprezzo / <i>surcharge</i>	370
lacca lucida / <i>polish lacquer</i>	sovrapprezzo / <i>surcharge</i>	1.190
altre finiture frontale other frontal finishings		
pietra preziosa "labradorite" / <i>"labradorite" precious gemstone</i>	sovrapprezzo / <i>surcharge</i>	6.800
pietra preziosa "occhio di ferro" - "occhio di tigre" / <i>"occhio di ferro" - "occhio di tigre" precious gemstone</i>	sovrapprezzo / <i>surcharge</i>	7.955
pietra preziosa "malachite" / <i>"malachite" precious gemstone</i>	sovrapprezzo / <i>surcharge</i>	9.150
finiture acciaio steel finishings		
nicel spazzolato / <i>brushed nickel</i>	sovrapprezzo / <i>surcharge</i>	500

CONSOLLE | CONSOLE TABLE

volume / volume 0,712 m³
colli / boxes 1

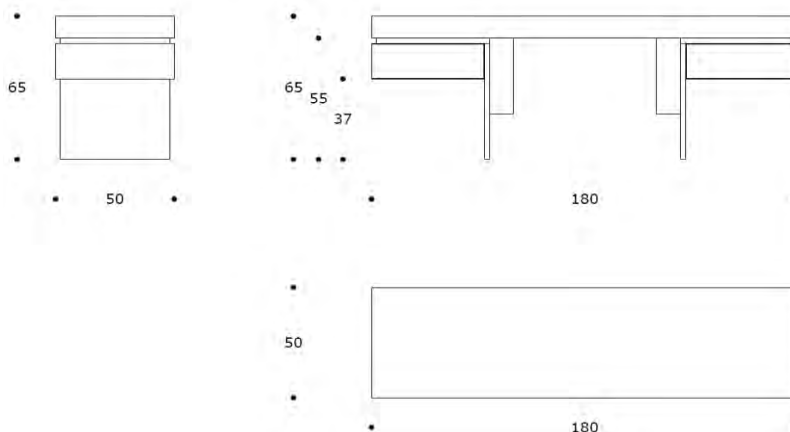

DESCRIZIONE / DESCRIPTION

CODICE / CODE

EURO / EURO

consolle in essenza palissandro opaco o tabacco opaco, 2 cassetti, dettagli in acciaio
effetto satinato opaco
*matt rosewood or matt tobacco rosewood console, 2 drawers, matt glazed effect steel
details*

CSFLOYD01

5.260

altre finiture
other finishings

palissandro lucido / *polish rosewood*
palissandro tabacco lucido / *polish tobacco rosewood*
piuma di noce e noce / *burr walnut and walnut*
piuma di noce e noce grigia / *grey burr walnut and w*
eucalipto frisè grigio opaco / *matt grey frisè eucalypt*
eucalipto frisè grigio lucido / *polish grey frisè eucalypt*

sovrapprezzo / *surcharge*
sovrapprezzo / *surcharge*
sovrapprezzo / *surcharge*
sovrapprezzo / *surcharge*
sovrapprezzo / *surcharge*
sovrapprezzo / *surcharge*

1.400
1.400
200
370
240
1.550

finiture acciaio
steel finishings

ghiaccio / *ice*
miele / *honey*

volume / volume 0,156 m³
colli / boxes 1

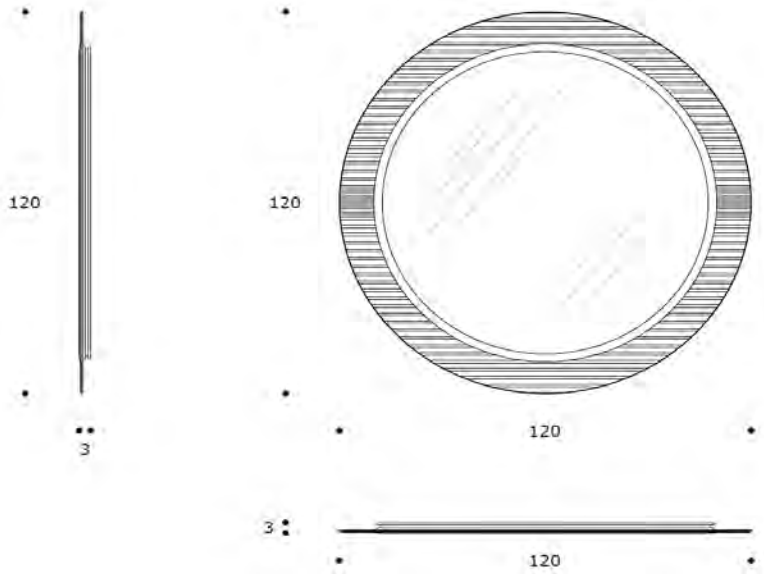

DESCRIZIONE / DESCRIPTION	CODICE / CODE	EURO / EURO
specchio in vetro bronzato completo di illuminazione, dettagli in acciaio <i>bronzed glass mirror with lighting, steel details</i>	SPAZAR01	2.750



volume / volume 0,795 m³
colli / boxes 2

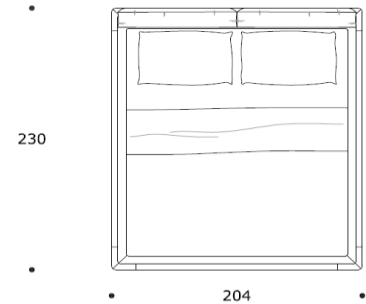
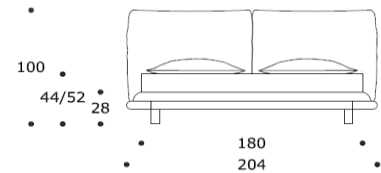
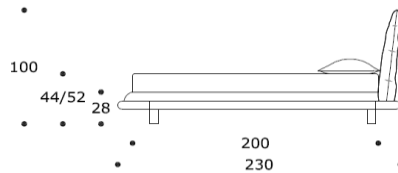

DESCRIZIONE / DESCRIPTION		CODICE / CODE	EURO / EURO
<p>letto matrimoniale imbottito fisso completo di giroletto, dettagli in massello di frassino <i>fix padded double bed with frame, solid ash wood details</i></p>		LTATLANT01	
tessuto rivestimento <i>fabric finishing</i>	<p>tessuto cliente ml *9,50 / C.O.M. fabric 1m *9,50</p> <p>tessuto cat. B / fabric cat. B</p> <p>tessuto cat. C / fabric cat. C</p> <p>tessuto cat. D / fabric cat. D</p> <p>tessuto cat. E / fabric cat. E</p> <p>tessuto cat. F / fabric cat. F</p> <p>tessuto cat. G / fabric cat. G</p> <p>tessuto cat. LUX / fabric cat. LUX</p>		<p>3.965</p> <p>4.900</p> <p>5.195</p> <p>5.455</p> <p>6.015</p> <p>6.575</p> <p>6.950</p> <p>8.625</p>
pelle rivestimento <i>leather finishing</i>	<p>pelle cliente* / C.O.M. leather*</p> <p>pelle cat. A / leather cat. A</p> <p>pelle cat. B / leather cat. B</p> <p>pelle cat. C / leather cat. C</p> <p>pelle cat. D / leather cat. D</p>		<p>4.360</p> <p>4.770</p> <p>5.480</p> <p>5.730</p> <p>6.235</p>
finitura massello di frassino <i>solid ash wood finishing</i>	<p>miele / honey</p> <p>moka / moka</p>		
optional <i>optional</i>	<p>rete a doghe 180×200 cm <i>slatted bedspring 180×200 cm</i></p> <p>materasso 180×200 h 20 cm <i>mattress 180×200 h 20 cm</i></p> <p>materasso 180×200 h 26 cm <i>mattress 180×200 h 26 cm</i></p>	<p>CPRETE02</p> <p>CPMATERA03</p> <p>CPMATERA06</p>	<p>745</p> <p>850</p> <p>1.165</p>

N.B. rivestimento in tessuto Amelie e Vamp non possibile
N.B. Amelie and Vamp fabric version not available

*TESSUTI E PELLI CLIENTE: La Smania Industria Italiana Mobili S.p.A., si riserva di verificare i materiali forniti dai clienti rispetto alle caratteristiche del prodotto e al tipo di rivestimento richiesto. Qualora questi materiali non siano considerati idonei, la stessa potrà decidere di non procedere con la lavorazione o, nel caso, di abbeditare, previa comunicazione al cliente, un sovrapprezzo.

*C.O.M. fabric & C.O.M. leather: Smania Industria Italiana Mobili S.p.A. reserves the right to verify the characteristics of the materials supplied by the customer and also the kind of materials requested. If the materials are not suitable to fit, we may consider not to accept or add an extra charged for possible extra workmanship, after notice.

* i tessuti sono calcolati senza rapporto / fabrics are calculated without repeat

ATLANTIS US STANDARD KING SIZE | LTATLANT03

SMANIA

LETTO MATRIMONIALE | DOUBLE BED

LETTI
BEDS

volume / volume 0,954 m³
colli / boxes 2

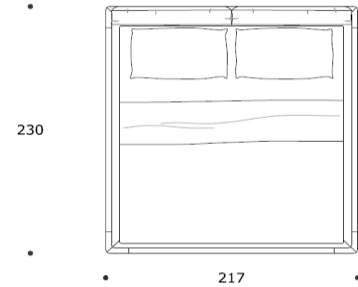
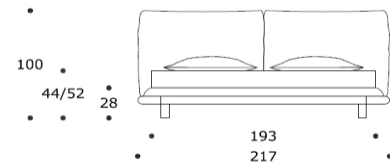
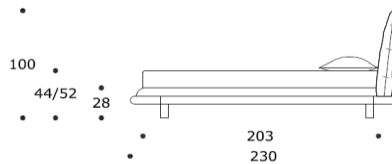

DESCRIZIONE / DESCRIPTION

CODICE / CODE

EURO / EURO

letto matrimoniale imbottito fisso completo di giroletto, dettagli in massello di frassino
fix padded double bed with frame, solid ash wood details

LTATLANT03

tessuto rivestimento
fabric finishing

tessuto cliente ml *10,50 / C.O.M. fabric lm *10,50
tessuto cat. B / fabric cat. B
tessuto cat. C / fabric cat. C
tessuto cat. D / fabric cat. D
tessuto cat. E / fabric cat. E
tessuto cat. F / fabric cat. F
tessuto cat. G / fabric cat. G
tessuto cat. LUX / fabric cat. LUX

4.125
5.095
5.405
5.675
6.255
6.840
7.230
8.970

pelle rivestimento
leather finishing

pelle cliente* / C.O.M. leather*
pelle cat. A / leather cat. A
pelle cat. B / leather cat. B
pelle cat. C / leather cat. C
pelle cat. D / leather cat. D

4.535
4.770
5.700
5.960
6.485

finitura massello di
frassino
solid ash wood
finishing

miele / honey
moka / moka

optional
optional

rete a doghe 193x203 cm
slatted bedspring 193x203 cm

CPRETE05

860

materasso 193x203 h 20 cm
mattress 193x203 h 20 cm

CPMATERA05

965

materasso 193x203 h 26 cm
mattress 193x203 h 26 cm

CPMATERA07

1.275

N.B. rivestimento in tessuto Amelie e Vamp non possibile
N.B. Amelie and Vamp fabric version not available

*TESSUTI E PELLI CLIENTE: La Smania Industria Italiana Mobili S.p.A., si riserva di verificare i materiali forniti dai clienti rispetto alle caratteristiche del prodotto e al tipo di rivestimento richiesto. Qualora questi materiali non siano considerati idonei, la stessa potrà decidere di non procedere con la lavorazione o, nel caso, di abbeditare, previa comunicazione al cliente, un sovrapprezzo.

*C.O.M. fabric & C.O.M. leather: Smania Industria Italiana Mobili S.p.A. reserves the right to verify the characteristics of the materials supplied by the customer and also the kind of materials requested. If the materials are not suitable to fit, we may consider not to accept or add an extra charged for possible extra workmanship, after notice.

* i tessuti sono calcolati senza rapporto / fabrics are calculated without repeat

volume / *volume* 0,651 m³
colli / *boxes* 2

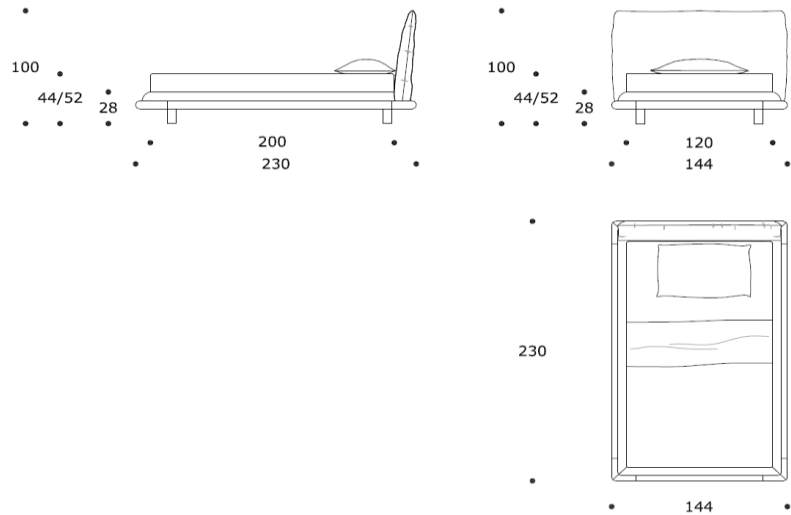

DESCRIZIONE / DESCRIPTION		CODICE / CODE	EURO / EURO
letto singolo 120 imbottito fisso completo di giroletto, dettagli in massello di frassino <i>fix padded single bed 120 with frame, solid ash wood details</i>		LTATLANTO2	
tessuto rivestimento <i>fabric finishing</i>	tessuto cliente ml *4,10 / <i>C.O.M. fabric 1m *4,10</i> tessuto cat. B / <i>fabric cat. B</i> tessuto cat. C / <i>fabric cat. C</i> tessuto cat. D / <i>fabric cat. D</i> tessuto cat. E / <i>fabric cat. E</i> tessuto cat. F / <i>fabric cat. F</i> tessuto cat. G / <i>fabric cat. G</i> tessuto cat. LUX / <i>fabric cat. LUX</i>		3.240 3.620 3.745 3.845 4.070 4.305 4.455 5.135
pelle rivestimento <i>leather finishing</i>	pelle cliente* / <i>C.O.M. leather*</i> pelle cat. A / <i>leather cat. A</i> pelle cat. B / <i>leather cat. B</i> pelle cat. C / <i>leather cat. C</i> pelle cat. D / <i>leather cat. D</i>		3.565 3.695 4.100 4.245 4.530
finitura massello di frassino <i>solid ash wood finishing</i>	miele / <i>honey</i> moka / <i>moka</i>		
optional <i>optional</i>	rete a doghe 120×200 cm <i>slatted bedspring 180×200 cm</i>	CPRETE15	355
	materasso 120×200 h 20 cm <i>mattress 120×200 h 20 cm</i>	CPMATERA08	575
	materasso 120×200 h 26 cm <i>mattress 120×200 h 26 cm</i>	CPMATERA09	790

N.B. rivestimento in tessuto Amelie e Vamp non possibile
N.B. Amelie and Vamp fabric version not available

*TESSUTI E PELLI CLIENTE: La Smania Industria Italiana Mobili S.p.A., si riserva di verificare i materiali forniti dai clienti rispetto alle caratteristiche del prodotto e al tipo di rivestimento richiesto. Qualora questi materiali non siano considerati idonei, la stessa potrà decidere di non procedere con la lavorazione o, nel caso, di abbeditare, previa comunicazione al cliente, un sovrapprezzo.

*C.O.M. fabric & C.O.M. leather: Smania Industria Italiana Mobili S.p.A. reserves the right to verify the characteristics of the materials supplied by the customer and also the kind of materials requested. If the materials are not suitable to fit, we may consider not to accept or add an extra charged for possible extra workmanship, after notice.

* i tessuti sono calcolati senza rapporto / *fabrics are calculated without repeat*

LETTI MATRIMONIALE | *DOUBLE BED*

LETTI
BEDS

volume / *volume* 2,027 m³
colli / *boxes* 2

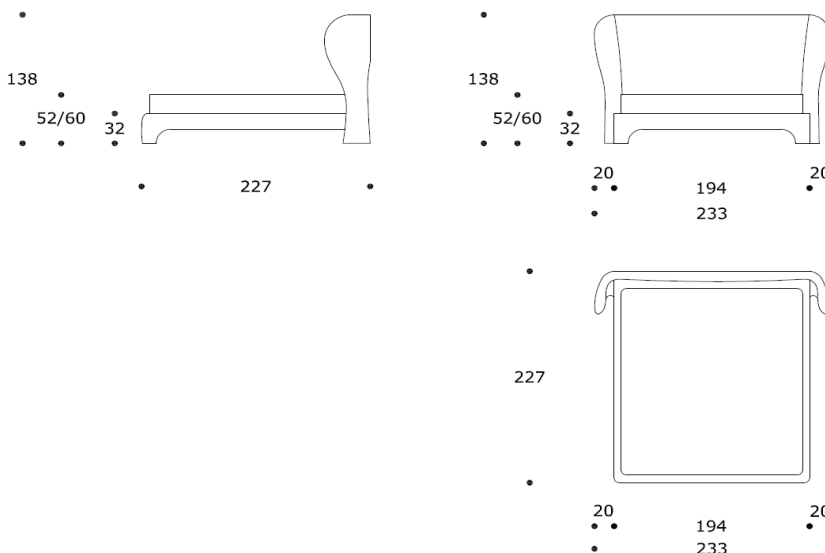

DESCRIZIONE / <i>DESCRIPTION</i>	CODICE / <i>CODE</i>	EURO / <i>EURO</i>
letto matrimoniale imbottito fisso completo di giroletto <i>fix padded double bed with frame</i>	LTKLIZIA01	
tessuto rivestimento <i>fabric finishing</i>		
tessuto cliente ml *10,50 / <i>C.O.M. fabric lm *10,50</i>		3.665
tessuto cat. B / <i>fabric cat. B</i>		4.850
tessuto cat. C / <i>fabric cat. C</i>		5.165
tessuto cat. D / <i>fabric cat. D</i>		5.445
tessuto cat. E / <i>fabric cat. E</i>		6.050
tessuto cat. F / <i>fabric cat. F</i>		6.635
tessuto cat. G / <i>fabric cat. G</i>		7.035
tessuto cat. LUX / <i>fabric cat. LUX</i>		8.840
pelle rivestimento <i>leather finishing</i>		
pelle cliente* / <i>C.O.M. leather*</i>		4.230
pelle cat. A / <i>leather cat. A</i>		4.485
pelle cat. B / <i>leather cat. B</i>		5.600
pelle cat. C / <i>leather cat. C</i>		5.905
pelle cat. D / <i>leather cat. D</i>		6.495
optional <i>optional</i>		
rete a doghe 180×200 cm <i>slatted bedspring 180×200 cm</i>	CPRETE02	745
materasso 180×200 h 20 cm <i>mattress 180×200 h 20 cm</i>	CPMATERA03	850
materasso 180×200 h 26 cm <i>mattress 180×200 h 26 cm</i>	CPMATERA06	1.165

N.B. rivestimento in tessuto Amelie e Vamp non possibile
N.B. Amelie and Vamp fabric version not available

*TESSUTI E PELLI CLIENTE: La Smania Industria Italiana Mobili S.p.A., si riserva di verificare i materiali forniti dai clienti rispetto alle caratteristiche del prodotto e al tipo di rivestimento richiesto. Qualora questi materiali non siano considerati idonei, la stessa potrà decidere di non procedere con la lavorazione o, nel caso, di abbeditare, previa comunicazione al cliente, un sovrapprezzo.

*C.O.M. fabric & C.O.M. leather: Smania Industria Italiana Mobili S.p.A. reserves the right to verify the characteristics of the materials supplied by the customer and also the kind of materials requested. If the materials are not suitable to fit, we may consider not to accept or add an extra charged for possible extra workmanship, after notice.

* i tessuti sono calcolati senza rapporto / *fabrics are calculated without repeat*

volume / *volume* 2,352 m³
colli / *boxes* 2

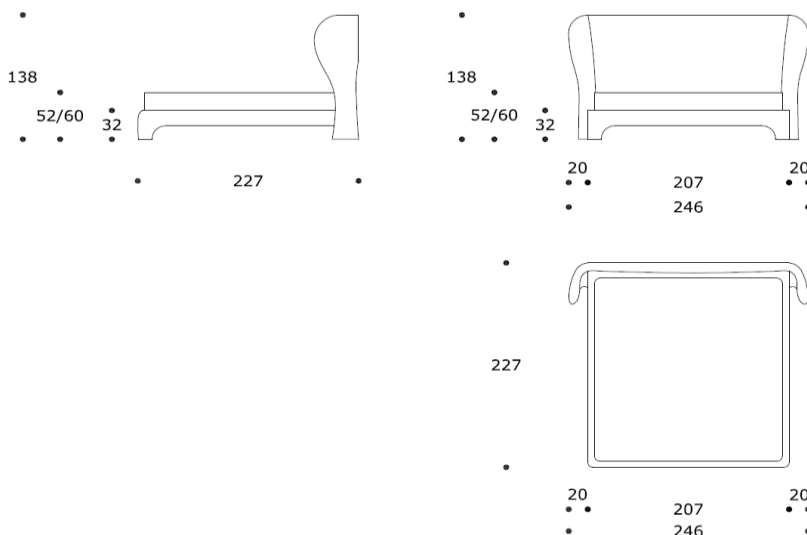

DESCRIZIONE / <i>DESCRIPTION</i>	CODICE / <i>CODE</i>	EURO / <i>EURO</i>
letto matrimoniale imbottito fisso completo di giroletto <i>fix padded double bed with frame</i>	LTKLIZIA02	
tessuto rivestimento <i>fabric finishing</i>		
tessuto cliente ml *11,50 / <i>C.O.M. fabric lm *11,50</i>		3.810
tessuto cat. B / <i>fabric cat. B</i>		5.045
tessuto cat. C / <i>fabric cat. C</i>		5.370
tessuto cat. D / <i>fabric cat. D</i>		5.660
tessuto cat. E / <i>fabric cat. E</i>		6.290
tessuto cat. F / <i>fabric cat. F</i>		6.900
tessuto cat. G / <i>fabric cat. G</i>		7.315
tessuto cat. LUX / <i>fabric cat. LUX</i>		9.195
pelle rivestimento <i>leather finishing</i>		
pelle cliente* / <i>C.O.M. leather*</i>		4.400
pelle cat. A / <i>leather cat. A</i>		4.665
pelle cat. B / <i>leather cat. B</i>		5.825
pelle cat. C / <i>leather cat. C</i>		6.140
pelle cat. D / <i>leather cat. D</i>		6.755
optional <i>optional</i>		
rete a doghe 193x203 cm <i>slatted bedspring 193x203 cm</i>	CPRETE05	860
materasso 193x203 h 20 cm <i>mattress 193x203 h 20 cm</i>	CPMATERA05	965
materasso 193x203 h 26 cm <i>mattress 193x203 h 26 cm</i>	CPMATERA07	1.275

N.B. rivestimento in tessuto Amelie e Vamp non possibile
N.B. Amelie and Vamp fabric version not available

*TESSUTI E PELLI CLIENTE: La Smania Industria Italiana Mobili S.p.A., si riserva di verificare i materiali forniti dai clienti rispetto alle caratteristiche del prodotto e al tipo di rivestimento richiesto. Qualora questi materiali non siano considerati idonei, la stessa potrà decidere di non procedere con la lavorazione o, nel caso, di abbeditare, previa comunicazione al cliente, un sovrapprezzo.

*C.O.M. fabric & C.O.M. leather: Smania Industria Italiana Mobili S.p.A. reserves the right to verify the characteristics of the materials supplied by the customer and also the kind of materials requested. If the materials are not suitable to fit, we may consider not to accept or add an extra charged for possible extra workmanship, after notice.

* i tessuti sono calcolati senza rapporto / *fabrics are calculated without repeat*



volume / volume 0,221 m³
colli / boxes 1

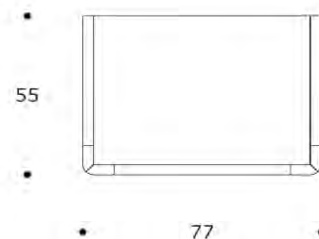
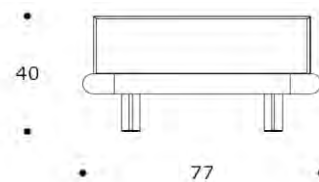
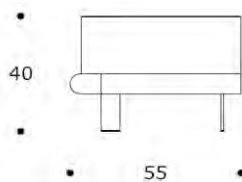

CASSETTONI, COMODINI E MOBILI TRUCCO
DRESSERS, NIGHTSTANDS AND VANITY DESKS

DESCRIZIONE / DESCRIPTION	CODICE / CODE	EURO / EURO
comodino in essenza di frassino laccato opaco, 1 cassetto, profili in massello di frassino, piedi in acciaio laccato opaco <i>matt lacquered ash wood nightstand, 1 drawer, solid ash wood details, matt lacquer steel legs</i>	COKIDA01	1.890
finiture struttura structure finishings		
	beige / beige	
	blu / blue	
	bordeaux / bordeaux	
	grigio / grey	
	grigio seta / silk grey	
	verde / green	

finitura massiccio di frassino solid ash wood finishing	miele / honey
	moka / moka

KIDA 190 | CAKIDA01

CASSETTONE | DRESSER

volume / volume 0,760 m³
colli / boxes 1

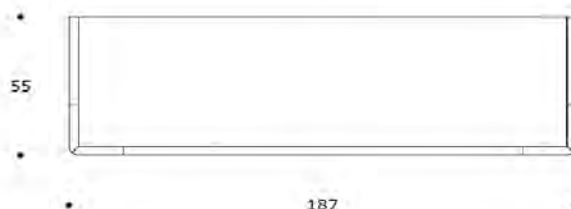
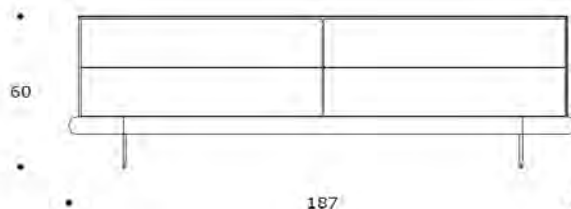
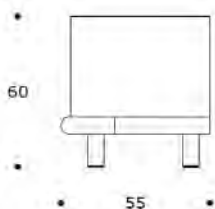

DESCRIZIONE / DESCRIPTION

CODICE / CODE

EURO / EURO

cassettone in essenza di frassino laccato opaco, 4 cassetti, profili in massello di frassino, piedi in acciaio laccato opaco
matt lacquered ash wood dresser, 4 drawers, solid ash wood details, matt lacquered steel legs

CAKIDA01

3.950

finiture struttura
structure finishings

beige / beige
blu / blue
bordeaux / bordeaux
grigio / grey
grigio seta / silk grey
verde / green

finitura massiccio di frassino
solid ash wood finishing

miele / honey
moka / moka

CASSETTONE | *DRESSER*

volume / volume 0,810 m³
colli / boxes 1

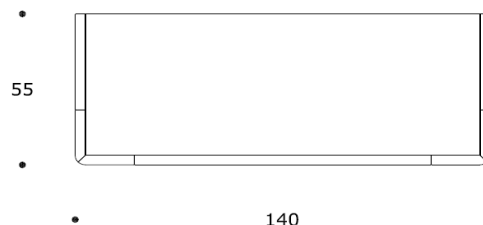
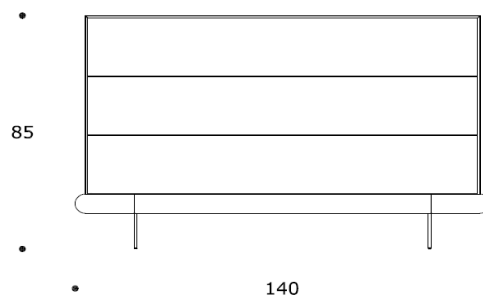
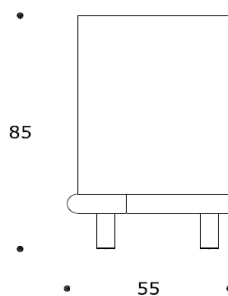

CASSETTONI, COMODINI E MOBILI TRUCCO
DRESSERS, NIGHTSTANDS AND VANITY DESKS

DESCRIZIONE / DESCRIPTION	CODICE / CODE	EURO / EURO
cassettone in essenza di frassino laccato opaco, 3 cassetti, profili in massello di frassino, piedi in acciaio laccato opaco <i>matt lacquered ash wood dresser, 3 drawers, solid ash wood details, matt lacquered steel legs</i>	CAKIDA01	3.480
finiture struttura structure finishings		
beige / beige blu / blue bordeaux / bordeaux grigio / grey grigio seta / silk grey verde / green		

finitura massiccio di frassino solid ash wood finishing	miele / honey moka / moka
--	------------------------------

ERMETE | MTERMETE01

MOBILE TRUCCO | VANITY DESK

volume / volume 0,879 m³
colli / boxes 1

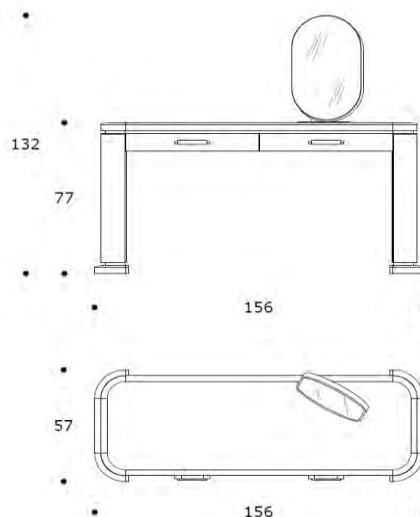
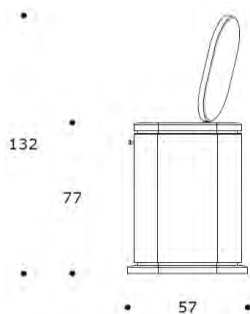

DESCRIZIONE / DESCRIPTION

CODICE / CODE

EURO / EURO

mobile trucco in essenza wengè, fianchi in pelle o "MicroNabuk", 2 cassetti, specchio in pelle, particolari in acciaio brunito spazzolato
wengè wood vanity desk, leather or "MicroNabuk" sides, 2 drawers, leather mirror, brushed bronzed steel details

MTERMETE01

rivestimento finishing

"MicroNabuk" / "MicroNabuk"

5.120

pelle cliente* / C.O.M. leather*
pelle cat. A-B-C-D / leather cat. A-B-C-D

4.940
5.200

altre finiture other finishings

palissandro opaco / matt rosewood
palissandro lucido / polish rosewood
palissandro tabacco opaco / matt tobacco rosewood
palissandro tabacco lucido / polish tobacco rosewood
piuma di noce e noce / burr walnut and walnut
piuma di noce e noce grigia /
grey burr walnut and grey walnut

sovrapprezzo / surcharge 150
sovrapprezzo / surcharge 995
sovrapprezzo / surcharge 150
sovrapprezzo / surcharge 995
sovrapprezzo / surcharge 240
sovrapprezzo / surcharge 275

altre finiture acciaio other steel finishings

nicel spazzolato / brushed nickel

sovrapprezzo / surcharge 145

volume / volume 0,048 m³
colli / boxes 1

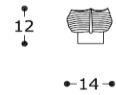
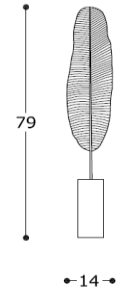
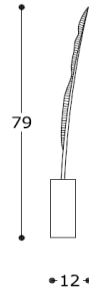

DESCRIZIONE / DESCRIPTION

CODICE / CODE

EURO / EURO

lampada da tavolo in acciaio finitura spazzolata, dettaglio in marmo "Nero Marquinia"
brushed finishing steel table lamp, "Nero Marquinia" marble detail

LMSAMSAR03

1.800

finitura
finishing

aubergine / aubergine
blu / blue
nero / black

N.B. profilo luminoso a led
N.B. led light profile

LAMPADA DA TERRA | FLOOR LAMP

ILLUMINAZIONE
LIGHTING

volume / volume 0,365 m³
colli / boxes 1

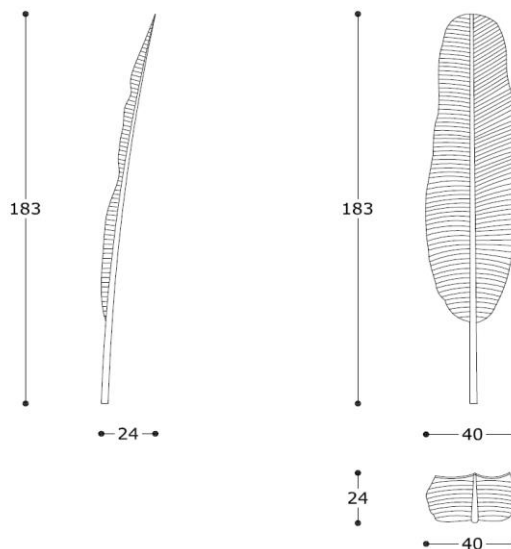

DESCRIZIONE / DESCRIPTION		CODICE / CODE	EURO / EURO
lampada da terra in acciaio finitura spazzolata <i>brushed finishing steel floor lamp</i>		LMSAMSAR02	1.300
finitura <i>finishing</i>	aubergine / <i>aubergine</i> blu / <i>blue</i> nero / <i>black</i>		
optional <i>optional</i>	base in marmo "Nero Marquinia" / <i>"Nero Marquinia" marble base</i>	sovrapprezzo / <i>surcharge</i>	730

N.B. profilo luminoso a led
N.B. led light profile

volume / volume 0,100 m³
colli / boxes 1

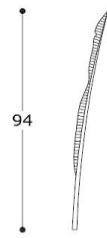

•14•

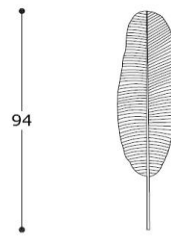

•23•

14



•23•

DESCRIZIONE / DESCRIPTION	CODICE / CODE	EURO / EURO
applique in acciaio finitura spazzolata brushed finishing steel applique	LMSAMSAR01	720
finitura finishing	aubergine / <i>aubergine</i> blu / <i>blue</i> nero / <i>black</i> platino / <i>platinum</i>	

SCULTURA | LMSCULTUR02

LAMPADA DA TERRA | FLOOR LAMP

volume / volume 0,667 m³
colli / boxes 1

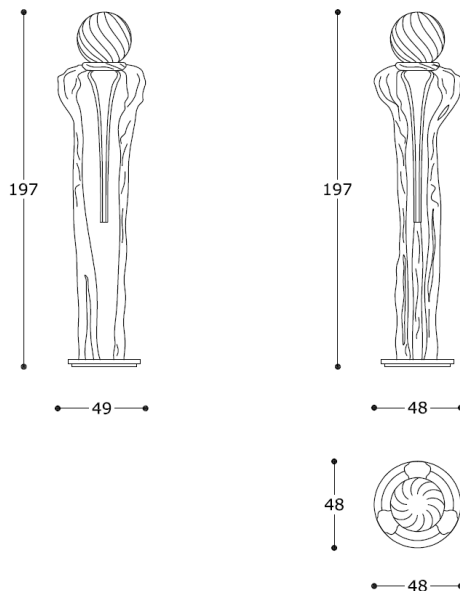

DESCRIZIONE / DESCRIPTION

CODICE / CODE

EURO / EURO

lampada da terra in resina finitura oro o argento, diffusori in vetro acidato,
base in marmo "Calacatta Cielo"
gold or silver resin floor lamp, glass diffusers, "Calacatta Cielo" marble base

LMSCULTUR02

3.650

N.B. 2 lampade G9 led
N.B. 2 led G9

SHUTTLE | LMSHUTTLO2

SMANIA

LAMPADA DA TAVOLO | TABLE LAMP

ILLUMINAZIONE
LIGHTING

volume / volume 0,063 m³
colli / boxes 1

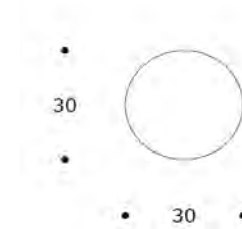
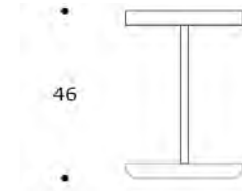
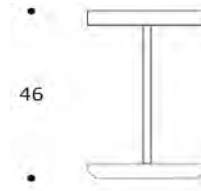

DESCRIZIONE / DESCRIPTION	CODICE / CODE	EURO / EURO
lampada da tavolo in alluminio anodizzato anodized aluminium table lamp	LMSHUTTLO2	1.230
finitura finishing	acciaio / steel grey oro / gold	

N.B. pannello luminoso a led 12 W

N.B. led light panel 12 W

SHUTTLE | LMSHUTTLO1

LAMPADA DA TERRA | FLOOR LAMP

volume / volume 0,190 m³
colli / boxes 1

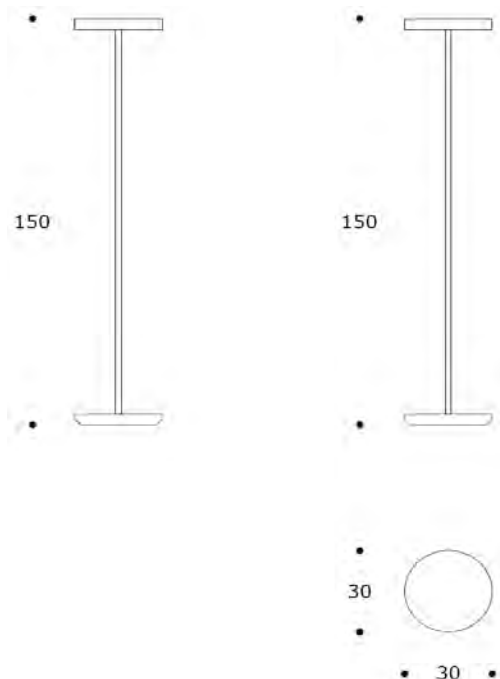

DESCRIZIONE / DESCRIPTION

CODICE / CODE

EURO / EURO

lampada da terra in alluminio anodizzato
anodized aluminium floor lamp

LMSHUTTLO1

1.390

finitura
finishing

acciaio / steel grey
oro / gold

N.B. pannello luminoso a led 12 W**N.B. led light panel 12 W**

KEPLERO | LMKEPLER01

LAMPADARIO | CHANDELIER

volume / volume 0,000 m³
colli / boxes 1

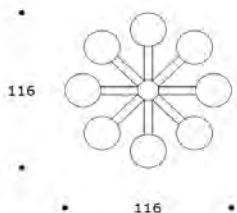
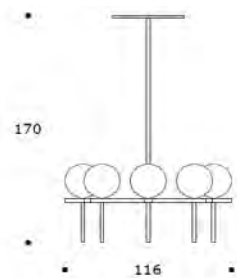
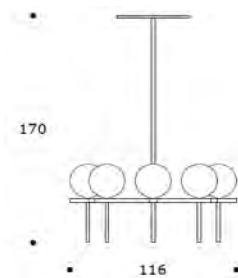

DESCRIZIONE / DESCRIPTION		CODICE / CODE	EURO / EURO
lampadario in acciaio brunito spazzolato, diffusori in vetro bianco acidato <i>brushed bronzed steel chandelier, white glass diffusers</i>		LMKEPLER01	7.440
altre finiture acciaio other steel finishings	nichel spazzolato / <i>brushed nickel</i>	sovrapprezzo / <i>surcharge</i>	550

N.B. 16 lampade led attacco G9

N.B. 16 led G9





volume / volume 0,496 / 0,416 / 0,336 m³
colli / boxes 1

DESCRIZIONE / DESCRIPTION		CODICE / CODE	EURO / EURO
tappeto in lapin naturale con cornice <i>natural lapin bed carpet with edge</i>			
misure sizes	400x300 cm	TPDEVON05	12.750
	350x250 cm	TPDEVON06	9.415
	300x200 cm	TPDEVON07	6.470
finitura lapin lapin finishing	melange grigio / <i>grey melange</i>		

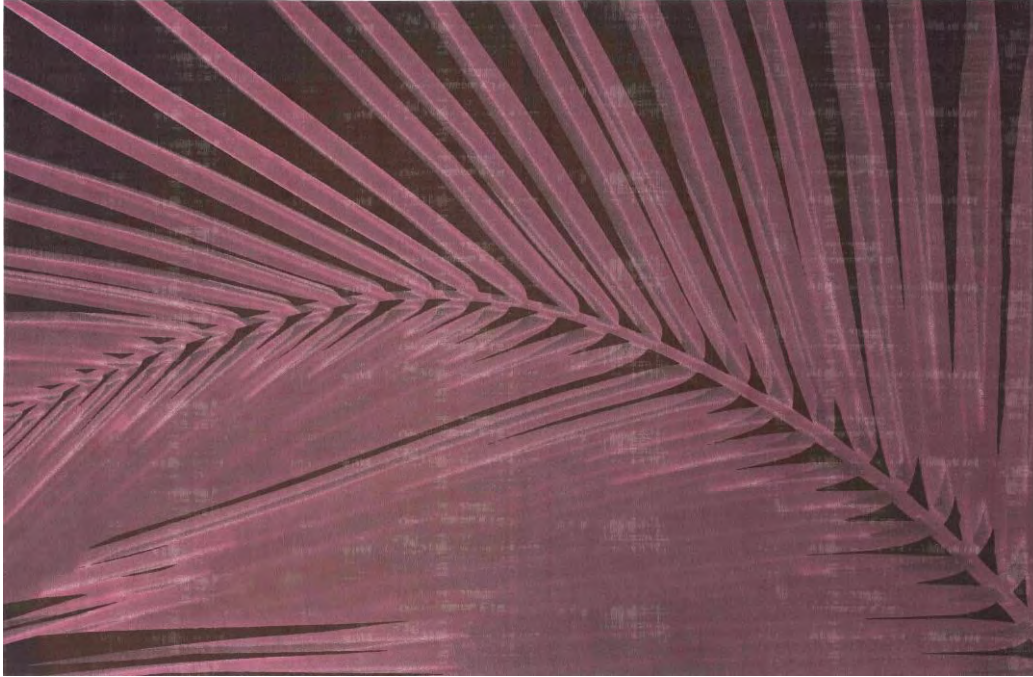

volume / volume 0,496
colli / boxes 1

DESCRIZIONE / DESCRIPTION		CODICE / CODE	EURO / EURO
<p>stuoia stampata <i>printed carpet</i></p>		TPPALM01	2.570
misure sizes	400x300 cm		
finitura finish	beige / <i>beige</i> verde / <i>green</i> viola / <i>purple</i>		

volume / volume 0,656 / 0,576 / 0,496
colli / boxes 1

DESCRIZIONE / DESCRIPTION		CODICE / CODE	EURO / EURO
tappeto in viscosa viscose carpet			
misure sizes	Ø 400 cm	TPSWEET03	5.860
	Ø 350 cm	TPSWEET02	4.550
	400x300 cm	TPSWEET01	4.465
finitura finishing	marrone / brown grigio / grey		



volume / volume 0,496 / 0,416 / 0,336 m³
colli / boxes 1

DESCRIZIONE / DESCRIPTION		CODICE / CODE	EURO / EURO
tappeto in volpe argentata naturale <i>natural silver fox carpet</i>			
misure sizes	400x300 cm	TPTHORN06	11.880
	350x250 cm	TPTHORN07	9.060
	300x200 cm	TPTHORN08	6.910



volume / volume 0,496
colli / boxes 1

DESCRIZIONE / DESCRIPTION	CODICE / CODE	EURO / EURO
<p>stuoia stampata <i>printed carpet</i></p>		
<p>misure sizes</p> <p>400×300 cm</p>	<p>TPTROPIC01</p>	<p>2.570</p>



PALM LEAVES | CPPALM01

PANNELLO DECORATIVO | DECORATIVE PANEL



volume / volume 0,163 m³
colli / boxes 1



DESCRIZIONE / DESCRIPTION	CODICE / CODE	EURO / EURO
pannello decorativo rettangolare <i>rectangular decorative panel</i>	CPPALM01	2.120

SEED | CPSEED01

PANNELLO DECORATIVO | *DECORATIVE PANEL*



volume / volume 0,131 m³
colli / boxes 1



DESCRIZIONE / <i>DESCRIPTION</i>	CODICE / <i>CODE</i>	EURO / <i>EURO</i>
pannello decorativo rettangolare <i>rectangular decorative panel</i>	CPSEED01	2.120

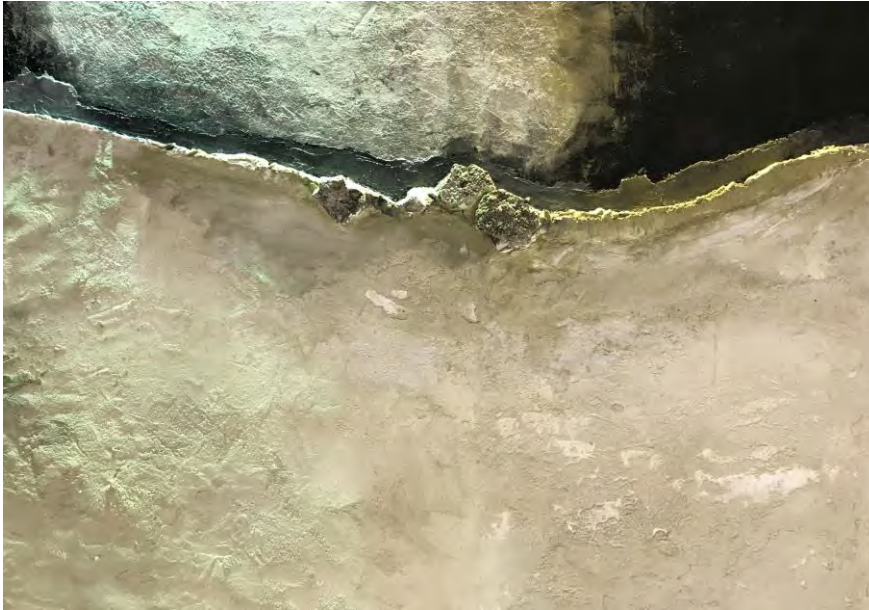

volume / *volume* 0,131 m³
colli / *boxes* 1



DESCRIZIONE / <i>DESCRIPTION</i>	CODICE / <i>CODE</i>	EURO / <i>EURO</i>
pannello decorativo rettangolare <i>rectangular decorative panel</i>	CPWEBER01	2.120



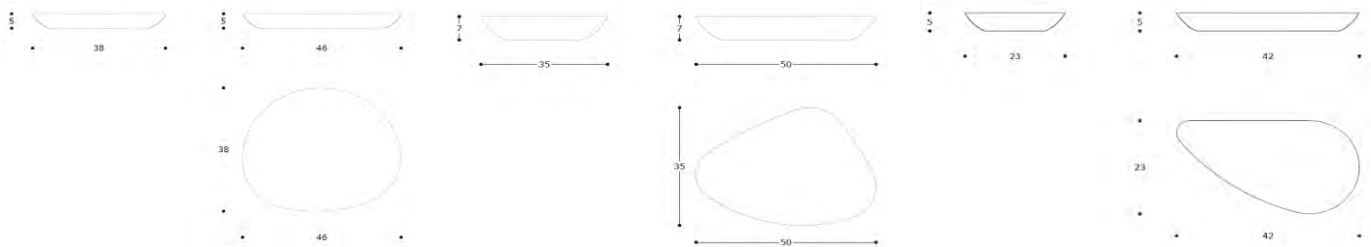

volume / volume 0,022/0,026/0,013 m³
colli / boxes 1

DESCRIZIONE / DESCRIPTION		CODICE / CODE	EURO / EURO
vassoio in ceramica finitura anticata antique finishing ceramic tray			
misure sizes	grande / big	CPALMA01	265
	medio / medium	CPALMA02	255
	piccolo / small	CPALMA03	205
finitura finishing	argento anticato / antique silver		
	rame anticato / antique copper		
	ottone anticato / antique brass		

VASSOIO | TRAY

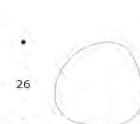
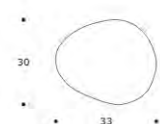

volume / volume 0,009/0,006 m³
colli / boxes 1

DESCRIZIONE / DESCRIPTION		CODICE / CODE	EURO / EURO
vassoio in ceramica finitura anticata <i>antique finishing ceramic tray</i>			
misure sizes	grande / <i>big</i> piccolo / <i>small</i>	CPEGLE01 CPEGLE02	255 170
finitura finishing	argento anticato / <i>antique silver</i> rame anticato / <i>antique copper</i> ottone anticato / <i>antique brass</i>		

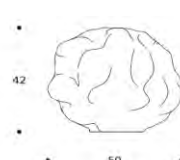

volume / volume 0,052/0,052 m³
colli / boxes 1

DESCRIZIONE / DESCRIPTION		CODICE / CODE	EURO / EURO
vaso in ceramica finitura anticata <i>antique finishing ceramic vase</i>			
misure sizes	alto / high basso / low	CPNIVES01 CPNIVES02	310 310
finitura finishing	argento anticato / <i>antique silver</i> rame anticato / <i>antique copper</i> ottone anticato / <i>antique brass</i>		





DESCRIZIONE / DESCRIPTION		CODICE / CODE	EURO / EURO
45x45 cm			
	cuscino / cushion	CPCUSC112	
	rivestimento / cover		185
	tessuto cliente ml* 0,55 / C.O.M. fabric 1m* 0,55		260
	tessuto CAT. B-C-D / fabric cat. B-C-D		305
	tessuto CAT. E-F-G / fabric cat. E-F-G		405
	tessuto CAT. LUX / fabric cat. LUX		405
	pelle cat. A-B-C-D / leather cat. A-B-C-D		325
	cuscino con bordo / cushion with edge	CPCUSC080	
	rivestimento / cover		185
	tessuto cliente ml* 0,55 / C.O.M. fabric 1m* 0,55		260
	tessuto CAT. B-C-D / fabric cat. B-C-D		305
	tessuto CAT. E-F-G / fabric cat. E-F-G		405
	tessuto CAT. LUX / fabric cat. LUX		405
	pelle cat. A-B-C-D / leather cat. A-B-C-D		325
	cuscino con bordo e bottone / cushion with edge and button	CPCUSC001	
	rivestimento / cover		195
	tessuto cliente ml* 0,55 / C.O.M. fabric 1m* 0,55		270
	tessuto CAT. B-C-D / fabric cat. B-C-D		315
	tessuto CAT. E-F-G / fabric cat. E-F-G		415
	tessuto CAT. LUX / fabric cat. LUX		415
	pelle cat. A-B-C-D / leather cat. A-B-C-D		330
	cuscino con nervetto / cushion with trimming	CPCUSC087	
	rivestimento / cover		185
	tessuto cliente ml* 0,55 / C.O.M. fabric 1m* 0,55		260
	tessuto CAT. B-C-D / fabric cat. B-C-D		305
	tessuto CAT. E-F-G / fabric cat. E-F-G		405
	tessuto CAT. LUX / fabric cat. LUX		405
	pelle cat. A-B-C-D / leather cat. A-B-C-D		325
	cuscino con profilo / cushion with edging	CPCUSC105	
	rivestimento / cover		185
	tessuto cliente ml* 0,55 / C.O.M. fabric 1m* 0,55		260
	tessuto CAT. B-C-D / fabric cat. B-C-D		305
	tessuto CAT. E-F-G / fabric cat. E-F-G		405
	tessuto CAT. LUX / fabric cat. LUX		405
	pelle cat. A-B-C-D / leather cat. A-B-C-D		325

*TESSUTI E PELLI CLIENTE: La Smania Industria Italiana Mobili S.p.A., si riserva di verificare i materiali forniti dai clienti rispetto alle caratteristiche del prodotto e al tipo di rivestimento richiesto. Qualora questi materiali non siano considerati idonei, la stessa potrà decidere di non procedere con la lavorazione o, nel caso, di abbeditare, previa comunicazione al cliente, un sovrapprezzo.

*C.O.M. fabric & C.O.M. leather: Smania Industria Italiana Mobili S.p.A. reserves the right to verify the characteristics of the materials supplied by the customer and also the kind of materials requested. If the materials are not suitable to fit, we may consider not to accept or add an extra charged for possible extra workmanship, after notice.



* i tessuti sono calcolati senza rapporto / fabrics are calculated without repeat

DESCRIZIONE / DESCRIPTION		CODICE / CODE	EURO / EURO
50x50 cm			
	cuscinò / cushion rivestimento / cover tessuto cliente ml* 0,60 / C.O.M. fabric 1m* 0,60 tessuto CAT. B-C-D / fabric cat. B-C-D tessuto CAT. E-F-G / fabric cat. E-F-G tessuto CAT. LUX / fabric cat. LUX pelle cat. A-B-C-D / leather cat. A-B-C-D	CPCUSC071	185 260 305 405 325
	cuscinò con bordo / cushion with edge rivestimento / cover tessuto cliente ml* 0,60 / C.O.M. fabric 1m* 0,60 tessuto CAT. B-C-D / fabric cat. B-C-D tessuto CAT. E-F-G / fabric cat. E-F-G tessuto CAT. LUX / fabric cat. LUX pelle cat. A-B-C-D / leather cat. A-B-C-D	CPCUSC009	195 270 315 415 330
	cuscinò con bordo e bottone / cushion with edge and button rivestimento / cover tessuto cliente ml* 0,60 / C.O.M. fabric 1m* 0,60 tessuto CAT. B-C-D / fabric cat. B-C-D tessuto CAT. E-F-G / fabric cat. E-F-G tessuto CAT. LUX / fabric cat. LUX pelle cat. A-B-C-D / leather cat. A-B-C-D	CPCUSC002	200 275 320 420 330
	cuscinò con nervetto / cushion with trimming rivestimento / cover tessuto cliente ml* 0,60 / C.O.M. fabric 1m* 0,60 tessuto CAT. B-C-D / fabric cat. B-C-D tessuto CAT. E-F-G / fabric cat. E-F-G tessuto CAT. LUX / fabric cat. LUX pelle cat. A-B-C-D / leather cat. A-B-C-D	CPCUSC088	185 260 305 405 325
	cuscinò con profilo / cushion with edging rivestimento / cover tessuto cliente ml* 0,60 / C.O.M. fabric 1m* 0,60 tessuto CAT. B-C-D / fabric cat. B-C-D tessuto CAT. E-F-G / fabric cat. E-F-G tessuto CAT. LUX / fabric cat. LUX pelle cat. A-B-C-D / leather cat. A-B-C-D	CPCUSC106	185 260 305 405 325
50x30 cm			
	cuscinò / cushion rivestimento / cover tessuto cliente ml *0,60 / C.O.M. fabric 1m *0,60 tessuto CAT. B-C-D / fabric cat. B-C-D tessuto CAT. E-F-G / fabric cat. E-F-G tessuto CAT. LUX / fabric cat. LUX pelle cat. A-B-C-D / leather cat. A-B-C-D	CPCUSC101	135 215 225 305 230
	cuscinò con nervetto / cushion with trimming rivestimento / cover tessuto cliente ml *0,60 / C.O.M. fabric 1m *0,60 tessuto CAT. B-C-D / fabric cat. B-C-D tessuto CAT. E-F-G / fabric cat. E-F-G tessuto CAT. LUX / fabric cat. LUX pelle cat. A-B-C-D / leather cat. A-B-C-D	CPCUSC100	135 230 275 310 240
	cuscinò con profilo / cushion with edging rivestimento / cover tessuto cliente ml *0,60 / C.O.M. fabric 1m *0,60 tessuto CAT. B-C-D / fabric cat. B-C-D tessuto CAT. E-F-G / fabric cat. E-F-G tessuto CAT. LUX / fabric cat. LUX pelle cat. A-B-C-D / leather cat. A-B-C-D	CPCUSC107	135 220 230 310 240

*TESSUTI E PELLI CLIENTE: La Smania Industria Italiana Mobili S.p.A., si riserva di verificare i materiali forniti dai clienti rispetto alle caratteristiche del prodotto e al tipo di rivestimento richiesto. Qualora questi materiali non siano considerati idonei, la stessa potrà decidere di non procedere con la lavorazione o, nel caso, di abbeditare, previa comunicazione al cliente, un sovrapprezzo.

*C.O.M. fabric & C.O.M. leather: Smania Industria Italiana Mobili S.p.A. reserves the right to verify the characteristics of the materials supplied by the customer and also the kind of materials requested. If the materials are not suitable to fit, we may consider not to accept or add an extra charged for possible extra workmanship, after notice.





* i tessuti sono calcolati senza rapporto / fabrics are calculated without repeat

DESCRIZIONE / DESCRIPTION		CODICE / CODE	EURO / EURO
55x55 cm			
	cuscinò / cushion	CPCUSC072	
	rivestimento / cover		195
	tessuto cliente ml *0,65 / C.O.M. fabric 1m *0,65		285
	tessuto CAT. B-C-D / fabric cat. B-C-D		325
	tessuto CAT. E-F-G / fabric cat. E-F-G		430
	tessuto CAT. LUX / fabric cat. LUX		435
	perle cat. A-B-C-D / leather cat. A-B-C-D		
	cuscinò con nervetto / cushion with trimming	CPCUSC089	
	rivestimento / cover		200
tessuto cliente ml *0,65 / C.O.M. fabric 1m *0,65		290	
tessuto CAT. B-C-D / fabric cat. B-C-D		330	
tessuto CAT. E-F-G / fabric cat. E-F-G		435	
tessuto CAT. LUX / fabric cat. LUX		355	
perle cat. A-B-C-D / leather cat. A-B-C-D			
cuscinò con profilo / cushion with edging	CPCUSC108		
rivestimento / cover		200	
tessuto cliente ml *0,65 / C.O.M. fabric 1m *0,65		290	
tessuto CAT. B-C-D / fabric cat. B-C-D		330	
tessuto CAT. E-F-G / fabric cat. E-F-G		435	
tessuto CAT. LUX / fabric cat. LUX		435	
perle cat. A-B-C-D / leather cat. A-B-C-D		355	
60x60 cm			
	cuscinò / cushion	CPCUSC096	
	rivestimento / cover		225
	tessuto cliente ml *0,70 / C.O.M. fabric 1m *0,70		315
	tessuto CAT. B-C-D / fabric cat. B-C-D		355
	tessuto CAT. E-F-G / fabric cat. E-F-G		455
	tessuto CAT. LUX / fabric cat. LUX		455
	perle cat. A-B-C-D / leather cat. A-B-C-D		380
	cuscinò con nervetto / cushion with trimming	CPCUSC097	
	rivestimento / cover		230
tessuto cliente ml *0,70 / C.O.M. fabric 1m *0,70		320	
tessuto CAT. B-C-D / fabric cat. B-C-D		360	
tessuto CAT. E-F-G / fabric cat. E-F-G		460	
tessuto CAT. LUX / fabric cat. LUX		460	
perle cat. A-B-C-D / leather cat. A-B-C-D		385	
cuscinò con profilo / cushion with edging	CPCUSC109		
rivestimento / cover		230	
tessuto cliente ml *0,70 / C.O.M. fabric 1m *0,70		320	
tessuto CAT. B-C-D / fabric cat. B-C-D		360	
tessuto CAT. E-F-G / fabric cat. E-F-G		460	
tessuto CAT. LUX / fabric cat. LUX		460	
perle cat. A-B-C-D / leather cat. A-B-C-D		385	

*TESSUTI E PELLI CLIENTE: La Smania Industria Italiana Mobili S.p.A., si riserva di verificare i materiali forniti dai clienti rispetto alle caratteristiche del prodotto e al tipo di rivestimento richiesto. Qualora questi materiali non siano considerati idonei, la stessa potrà decidere di non procedere con la lavorazione o, nel caso, di abbeditare, previa comunicazione al cliente, un sovrapprezzo.

*C.O.M. fabric & C.O.M. leather: Smania Industria Italiana Mobili S.p.A. reserves the right to verify the characteristics of the materials supplied by the customer and also the kind of materials requested. If the materials are not suitable to fit, we may consider not to accept or add an extra charged for possible extra workmanship, after notice.

* i tessuti sono calcolati senza rapporto / fabrics are calculated without repeat

DESCRIZIONE / DESCRIPTION		CODICE / CODE	EURO / EURO
70x70 cm			
	cuscinò / cushion rivestimento / cover tessuto cliente ml *0,80 / C.O.M. fabric lm *0,80 tessuto CAT. B-C-D / fabric cat. B-C-D tessuto CAT. E-F-G / fabric cat. E-F-G tessuto CAT. LUX / fabric cat. LUX pelle cat. A-B-C-D / leather cat. A-B-C-D	CPCUSC079	270 370 385 490 435
	cuscinò con nervetto / cushion with trimming rivestimento / cover tessuto cliente ml *0,80 / C.O.M. fabric lm *0,80 tessuto CAT. B-C-D / fabric cat. B-C-D tessuto CAT. E-F-G / fabric cat. E-F-G tessuto CAT. LUX / fabric cat. LUX pelle cat. A-B-C-D / leather cat. A-B-C-D	CPCUSC090	275 375 390 495 440
	cuscinò con profilo / cushion with edging rivestimento / cover tessuto cliente ml *0,80 / C.O.M. fabric lm *0,80 tessuto CAT. B-C-D / fabric cat. B-C-D tessuto CAT. E-F-G / fabric cat. E-F-G tessuto CAT. LUX / fabric cat. LUX pelle cat. A-B-C-D / leather cat. A-B-C-D	CPCUSC110	275 375 390 495 440
CONTINENTAL 70x70 cm			
	cuscinò / cushion rivestimento fronte / front cover montone natural beige / beige natural sheepskin montone mussmann marrone / brown mussmann sheepskin montone brisa grigio / grey brisa sheepskin montone brisa cielo / blue sky brisa sheepskin rivestimento retro / back cover tessuto cliente ml *0,80 / C.O.M. fabric lm *0,80 tessuto cat. B-C-D-E-F-G-LUX / fabric cat. B-C-D-E-F-G-LUX pelle cat. A-B-C-D / leather cat. A-B-C-D	CPCUSC082	690 770 770
THORN 60x60 cm			
	cuscinò / cushion rivestimento fronte / front cover volpe argentata naturale / natural silver fox rivestimento retro / back cover tessuto cliente ml *0,70 / C.O.M. fabric lm *0,70 tessuto cat. B-C-D-E-F-G-LUX / fabric cat. B-C-D-E-F-G-LUX pelle cat. A-B-C-D / leather cat. A-B-C-D	CPCUSC098	605 680 680
WILLY 60x60 cm			
	cuscinò / cushion rivestimento fronte / front cover coyote naturale / natural coyote rivestimento retro / back cover tessuto cliente ml *0,70 / C.O.M. fabric lm *0,70 tessuto cat. B-C-D-E-F-G-LUX / fabric cat. B-C-D-E-F-G-LUX pelle cat. A-B-C-D / leather cat. A-B-C-D	CPCUSC099	640 715 715



*TESSUTI E PELLI CLIENTE: La Smania Industria Italiana Mobili S.p.A., si riserva di verificare i materiali forniti dai clienti rispetto alle caratteristiche del prodotto e al tipo di rivestimento richiesto. Qualora questi materiali non siano considerati idonei, la stessa potrà decidere di non procedere con la lavorazione o, nel caso, di abbeditare, previa comunicazione al cliente, un sovrapprezzo.

*C.O.M. fabric & C.O.M. leather: Smania Industria Italiana Mobili S.p.A. reserves the right to verify the characteristics of the materials supplied by the customer and also the kind of materials requested. If the materials are not suitable to fit, we may consider not to accept or add an extra charged for possible extra workmanship, after notice.

* i tessuti sono calcolati senza rapporto / fabrics are calculated without repeat

DESCRIZIONE / DESCRIPTION	CODICE / CODE	EURO / EURO
LAPIN 60x60 cm		
 <p>cuscino / cushion rivestimento fronte / front cover lapin beige / beige lapin lapin marrone / brown lapin lapin menta / mint green lapin lapin perla / pearl lapin lapin rubino / rubty red lapin rivestimento retro / back cover tessuto cliente ml *0,70 / C.O.M. fabric lm *0,70 tessuto cat. B-C-D-E-F-G-LUX / fabric cat. B-C-D-E-F-G-LUX pelle cat. A-B-C-D / leather cat. A-B-C-D</p>	CPCUSC104	430 505 505

optional

 <p>stampa cavallo "Troy" a rilievo su cuscino in pelle (non possibile su pelle Ancestor, Cayman, Dundee, Tijus e Tigro) embossed "Troy" horse on leather cushion (not available on Ancestor, Cayman, Dundee, Tijus e Tigro)</p>	sovrapprezzo / surcharge	105
 <p>*cavallo "Troy" in cristallo "Swarovski" (possibile solo su velluto Azimut, Dolomiti, Pirandello, Vivaldi - pelli Nabuk e Florida) **Swarovski" crystal horse (available on Azimut, Dolomiti, Pirandello, Vivaldi velvet - Nabuk and Florida leather)</p>	sovrapprezzo / surcharge	240

*TESSUTI E PELLI CLIENTE: La Smania Industria Italiana Mobili S.p.A., si riserva di verificare i materiali forniti dai clienti rispetto alle caratteristiche del prodotto e al tipo di rivestimento richiesto. Qualora questi materiali non siano considerati idonei, la stessa potrà decidere di non procedere con la lavorazione o, nel caso, di abbeditare, previa comunicazione al cliente, un sovrapprezzo.

*C.O.M. fabric & C.O.M. leather: Smania Industria Italiana Mobili S.p.A. reserves the right to verify the characteristics of the materials supplied by the customer and also the kind of materials requested. If the materials are not suitable to fit, we may consider not to accept or add an extra charge for possible extra workmanship, after notice.

* i tessuti sono calcolati senza rapporto / fabrics are calculated without repeat

DESCRIZIONE / DESCRIPTION		CODICE / CODE	EURO / EURO
tessuto al metro h 130 → 150 cm <i>fabric per linear meter (h 130 → 150 cm)</i>		CPTESSUTO01	
categoria category	tessuto cat. B / <i>fabric cat. B</i>		115
	tessuto cat. C / <i>fabric cat. C</i>		160
	tessuto cat. D / <i>fabric cat. D</i>		190
	tessuto cat. E / <i>fabric cat. E</i>		255
	tessuto cat. F / <i>fabric cat. F</i>		325
	tessuto cat. G / <i>fabric cat. G</i>		370
	tessuto cat. LUX / <i>fabric cat. LUX</i>		575



DESCRIZIONE / DESCRIPTION	CODICE / CODE	EURO / EURO
campionario materiali samples box	ZABC24 netto / net price	575



DESCRIZIONE / DESCRIPTION

CODICE / CODE

EURO / EURO

logo			
logo			
misure			
sizes	120 cm	CPINSEGNA05 <i>netto / net price</i>	440
	150 cm	CPINSEGNA04 <i>netto / net price</i>	480
	250 cm	CPINSEGNA03 <i>netto / net price</i>	800

N.B. per la progettazione degli spazi Smania negli showroom rivolgersi al Design Department Smania

N.B. to design any Smania spaces in your showroom, please contact the Smania Design Department

ELEMENTO DIVISORIO

ELEMENTO DIVISORIO | DIVIDING ELEMENT

 SMANIA

CUSCINI, TESSUTI E CAMPIONARIO
CUSHIONS, FABRICS AND MATERIAL BOX

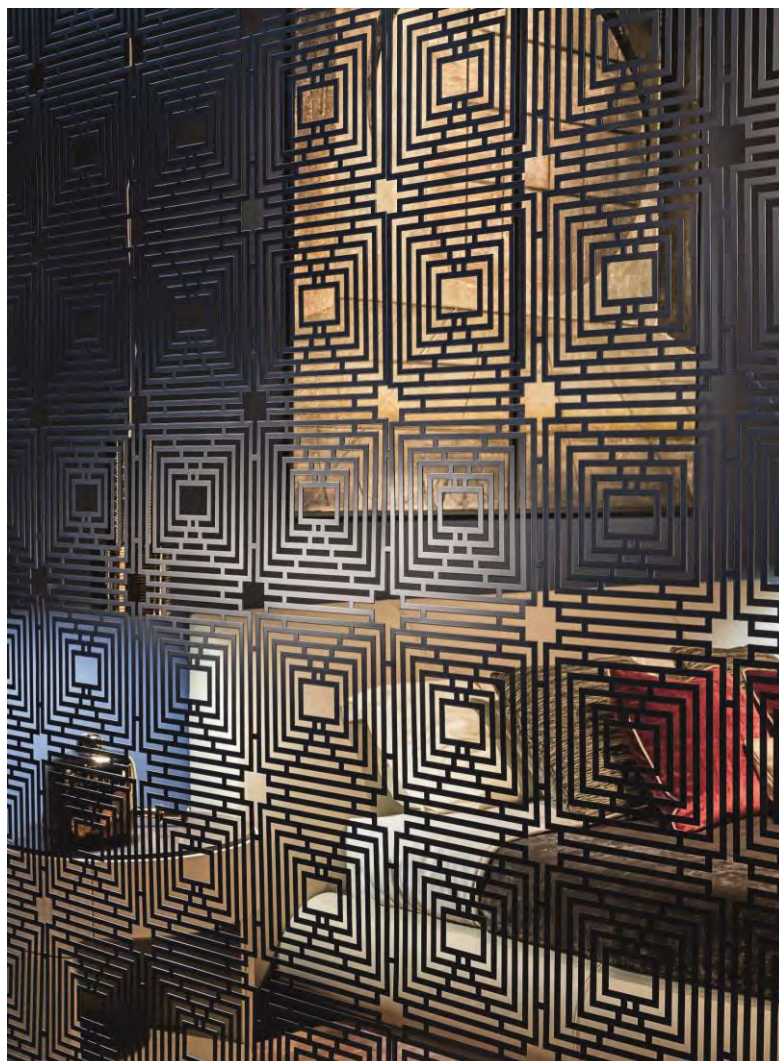

DESCRIZIONE / DESCRIPTION

CODICE / CODE

EURO / EURO

elemento divisorio
dividing element

misure

sizes

28 h 30 cm

84 h 90 cm

CPTXTURE01 *netto / net price*

CPTXTURE02 *netto / net price*

50

250

N.B. per la progettazione degli spazi Smania negli showroom rivolgersi al Design Department Smania
N.B. to design any Smania spaces in your showroom, please contact the Smania Design Department

LISTINO PREZZI INDOORUPDATE_19 / PRICE LIST INDOORUPDATE_19 rev. 00 06/19

87

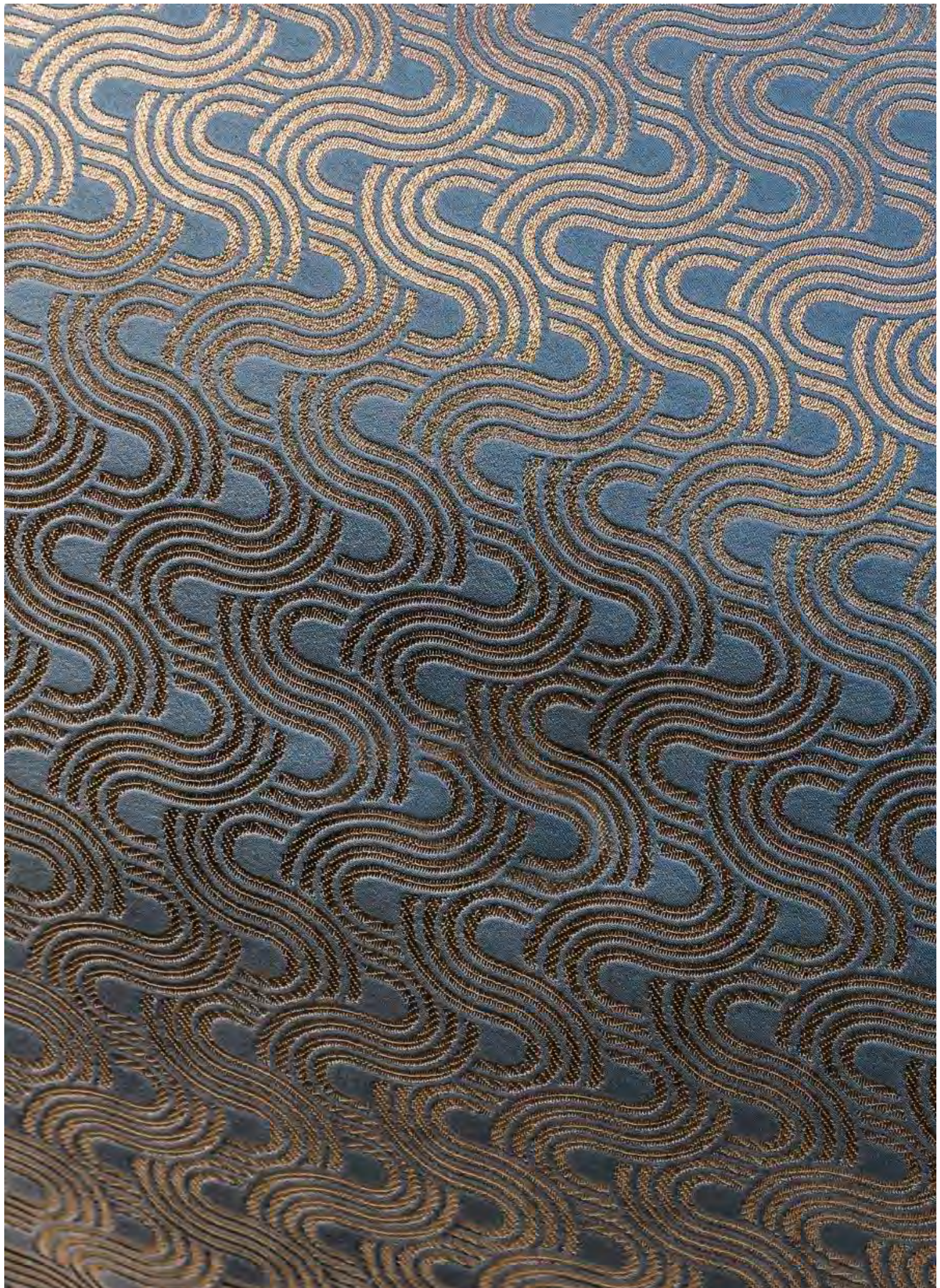

cat. A

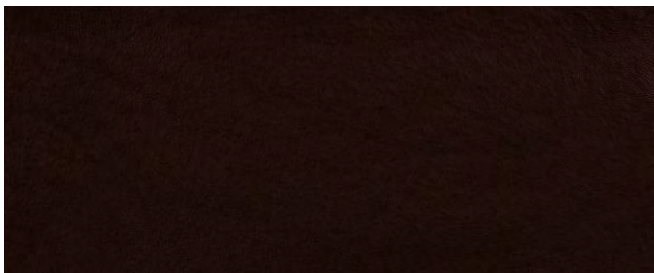

bicast marrone
brown bycast
COD. A02

cat. B



ancestor marrone
brown ancestor
COD. B01

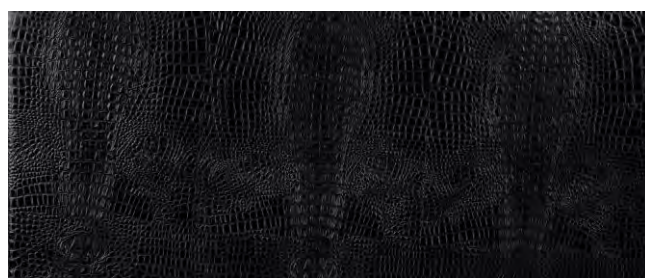

ancestor nero lucido
shiny black ancestor
COD. B17

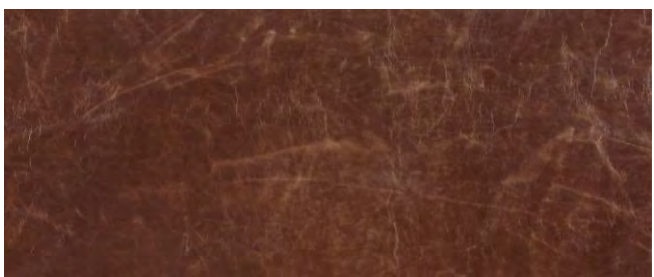

onix castagna
chestnut onix
COD. B47

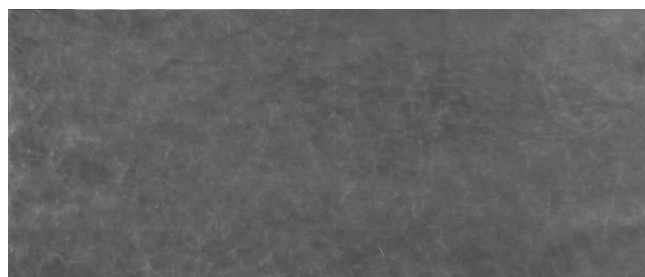

onix fumo
smoke onix
COD. B46

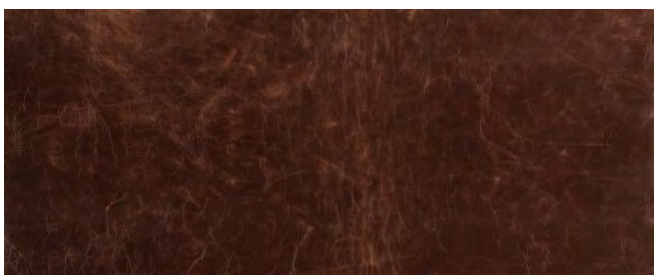

onix mogano
mahogany onix
COD. B48



scamosciato moro
brown suede
COD. B15

N.B.: la riproduzione su materiali diversi può riportare leggere differenze cromatiche rispetto agli originali.
NOTE: slight chromatic differences may result due to reproduction on different materials.

cat. C



africa grigio
grey africa
COD. C46



africa testa di moro
testa di moro africa
COD. C47



cayman grigio
grey cayman
COD. C48



cayman testa di moro
testa di moro cayman
COD. C49

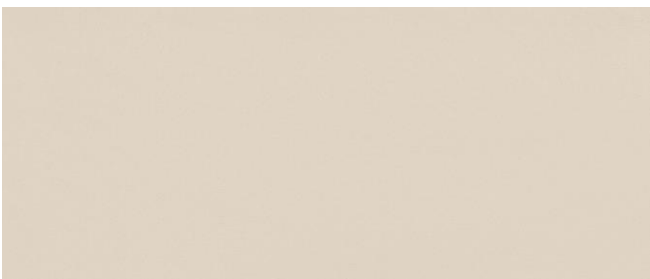

florida 198 ostraica
198 oyster florida
COD. C29



florida 207 camoscio
207 chamois florida
COD. C30

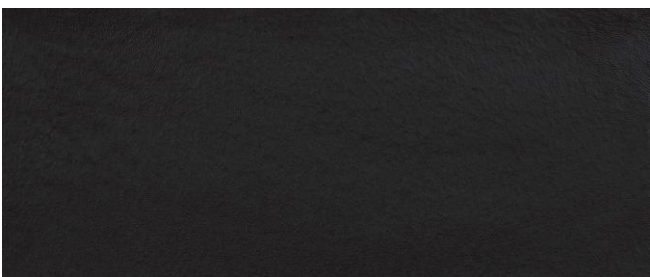

florida 2002 nero
2002 black florida
COD. C18



florida 2052 bianco
2052 white florida
COD. C19

N.B.: la riproduzione su materiali diversi può riportare leggere differenze cromatiche rispetto agli originali.
NOTE: slight chromatic differences may result due to reproduction on different materials.

cat. C



florida 2106 beige
2106 beige florida
COD. C16



florida 2040 marrone
2040 brown florida
COD. C17



florida 195 latte
195 milk white florida
COD. C60

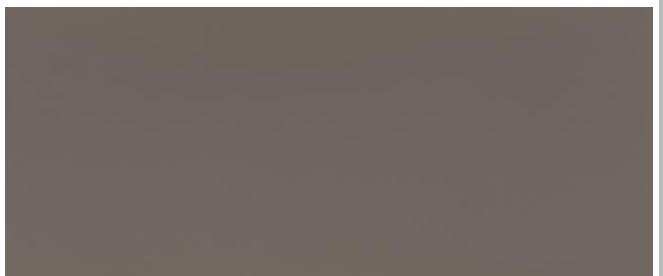

florida 218 marmotta
218 beaver florida
COD. C63



florida 202 peltro
202 grey florida
COD. C61

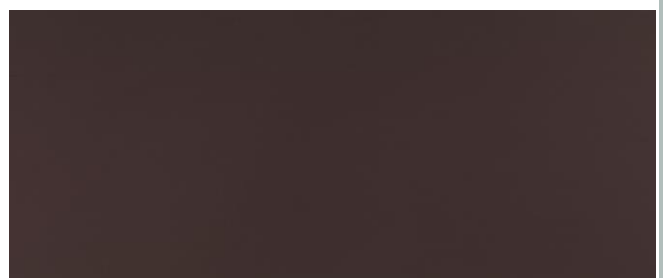

florida 108 carruba
108 carob florida
COD. C56



florida 164 ottanio
164 ottanio florida
COD. C59



florida 205 notte
205 midnight florida
COD. C62

N.B.: la riproduzione su materiali diversi può riportare leggere differenze cromatiche rispetto agli originali.
NOTE: slight chromatic differences may result due to reproduction on different materials.

cat. C



florida 128 abete
128 pine green florida
COD. C57



lux nero
black lux
COD. C35



nature acacia
acacia nature
COD. C28



nature sabbia
sand nature
COD. C27

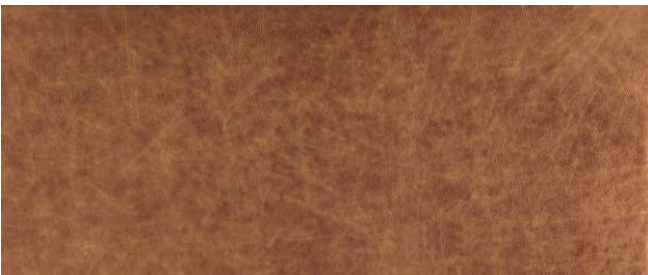

oregon cognac
cognac oregon
COD. C32



oregon grigio
grey oregon
COD. C33

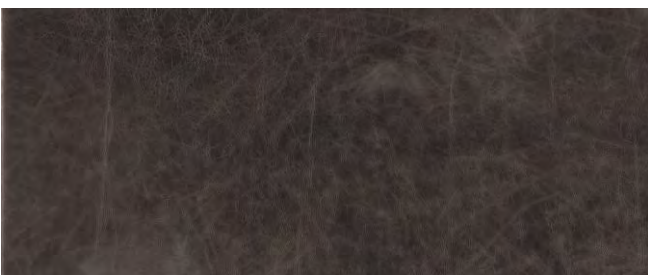

oregon testa di moro
testa di moro oregon
COD. C25

N.B.: la riproduzione su materiali diversi può riportare leggere differenze cromatiche rispetto agli originali.
NOTE: slight chromatic differences may result due to reproduction on different materials.

cat. D



dundee blu
blue dundee
COD. D07



dundee cipria
powder dundee
COD. C42



dundee crema
cream dundee
COD. D05

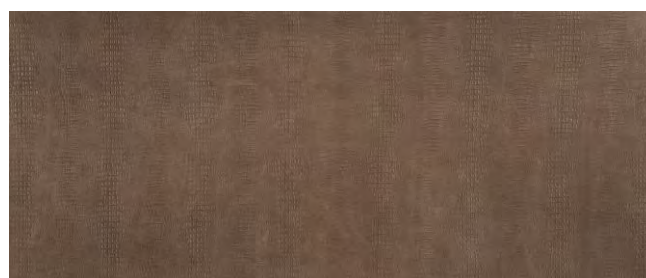

dundee fumè
fumè dundee
COD. C40



dundee ghiaccio
ice dundee
COD. D08



dundee grigio
grey dundee
COD. C41

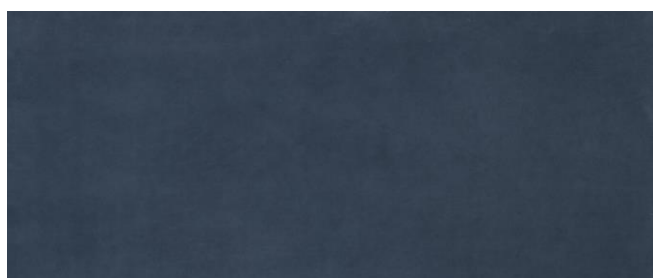

nabuk blu
blue nabuk
COD. D11



nabuk cipria
powder nabuk
COD. C23

N.B.: la riproduzione su materiali diversi può riportare leggere differenze cromatiche rispetto agli originali.
NOTE: slight chromatic differences may result due to reproduction on different materials.

cat. D



nabuk crema
cream nabuk
COD. D09



nabuk fumè
fumè nabuk
COD. C24

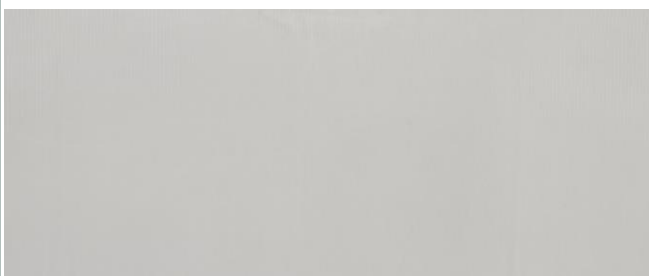

nabuk ghiaccio
ice nabuk
COD. D12



nabuk grigio
grey nabuk
COD. C22

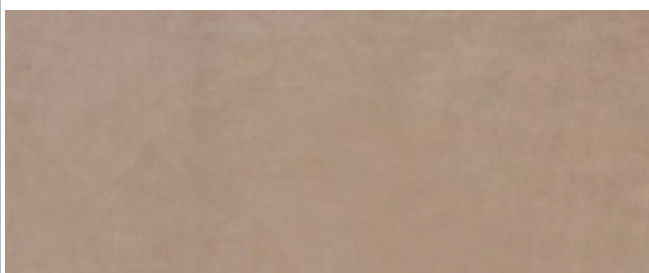

nabuk tortora
dove grey nabuk
COD. D14



savana fumè
fumè savana
COD. D04



savana grigio
grey savana
COD. D03

N.B.: la riproduzione su materiali diversi può riportare leggere differenze cromatiche rispetto agli originali.
NOTE: slight chromatic differences may result due to reproduction on different materials.

cat. B

h 130 → 150 cm / 130 → 150 cm h

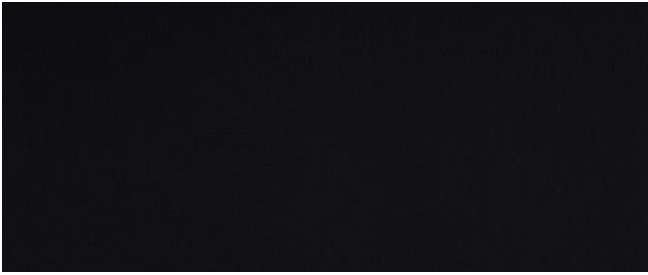

1252/07 amelie
1252/07 amelie
COD. TB007



502 abete azimut
502 pine green azimut
COD. TB024



704 ametista azimut
704 amethyst azimut
COD. TB027

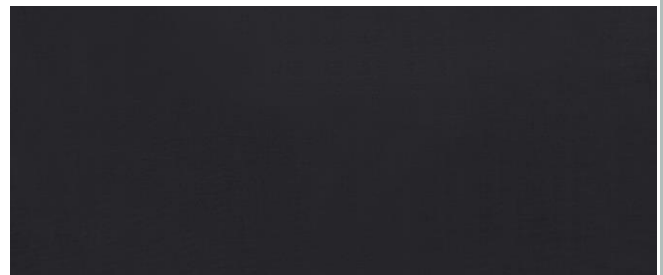

802 antracite azimut
802 dark grey azimut
COD. TB028



605 blu azimut
605 blue azimut
COD. TB025



104 bronzo azimut
104 bronze azimut
COD. TB021



804 fumo azimut
804 smoke grey azimut
COD. TB029



303 mattone azimut
303 brick red azimut
COD. TB023

N.B.: la riproduzione su materiali diversi può riportare leggere differenze cromatiche rispetto agli originali.

NOTE: slight chromatic differences may result due to reproduction on different materials.

N.B.: i tessuti sono calcolati senza rapporto / fabrics are calculated without repeat

cat. B

h 130 → 150 cm / 130 → 150 cm h



701 rosa azimut
701 pink azimut
COD. TB026

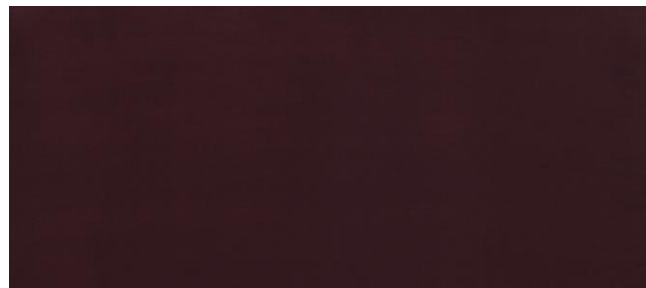

202 rubino azimut
202 ruby red azimut
COD. TB022



23062/611 antracite "MicroNabuk" Bros/Tiffany
23062/611 dark grey "MicroNabuk" Bros/Tiffany
COD. TB119



23062/011 beige "MicroNabuk" Bros/Tiffany
23062/011 beige "MicroNabuk" Bros/Tiffany
COD. TB136

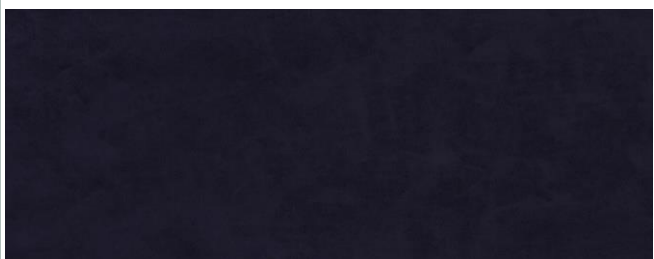

23062/19 blu "MicroNabuk" Bros/Tiffany
23062/19 blue "MicroNabuk" Bros/Tiffany
COD. TB139

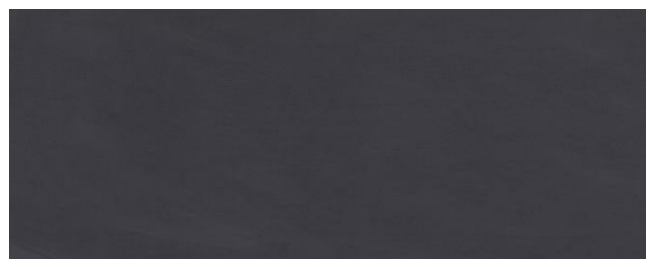

23062/626 grigio "MicroNabuk" Bros/Tiffany
23062/626 grey "MicroNabuk" Bros/Tiffany
COD. TB120

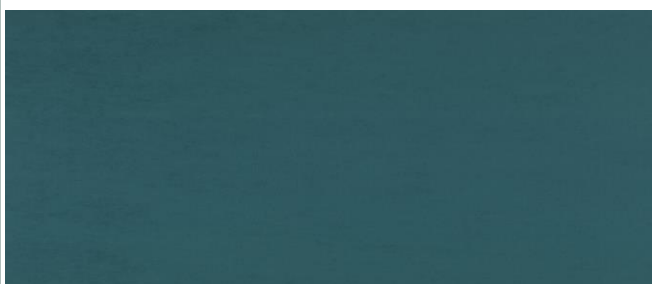

23062/809 menta "MicroNabuk" Bros/Tiffany
23062/809 mint green "MicroNabuk" Bros/Tiffany
COD. TB121

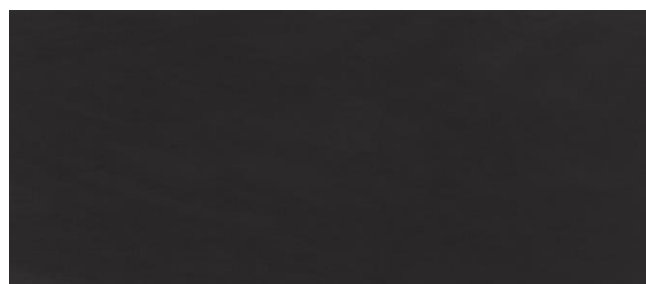

23062/200 nero "MicroNabuk" Bros/Tiffany
23062/200 black "MicroNabuk" Bros/Tiffany
COD. TB116

N.B.: la riproduzione su materiali diversi può riportare leggere differenze cromatiche rispetto agli originali.

NOTE: slight chromatic differences may result due to reproduction on different materials.

N.B.: i tessuti sono calcolati senza rapporto / fabrics are calculated without repeat

cat. B

h 130 → 150 cm / 130 → 150 cm h

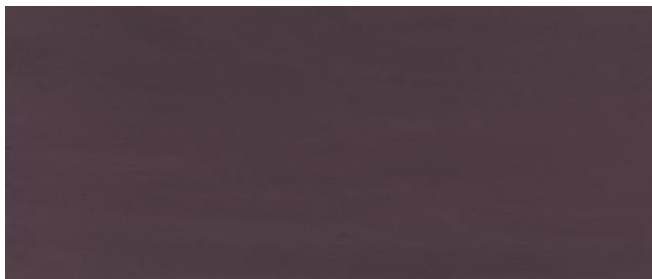

23062/010 prugna "MicroNabuk" Bros/Tiffany
23062/010 plum "MicroNabuk" Bros/Tiffany
COD. TB115



23062/405 testa di moro "MicroNabuk" Bros/Tiffany
23062/405 testa di moro "MicroNabuk" Bros/Tiffany
COD. TB117



23062/604 tortora "MicroNabuk" Bros/Tiffany
23062/604 dove grey "MicroNabuk" Bros/Tiffany
COD. TB118



228/12 antracite cielo
228/12 antracite cielo
COD. TB194

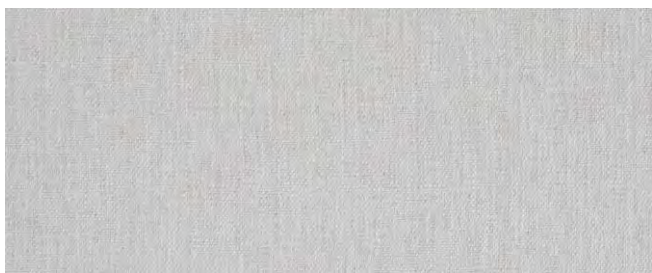

228/01 avorio cielo
228/01 ivory cielo
COD. TB188



228/03 beige cielo
228/03 beige cielo
COD. TB189



228/08 blu cielo
228/08 blue cielo
COD. TB192



228/10 grigio cielo
228/10 grey cielo
COD. TB193

N.B.: la riproduzione su materiali diversi può riportare leggere differenze cromatiche rispetto agli originali.

NOTE: slight chromatic differences may result due to reproduction on different materials.

N.B.: i tessuti sono calcolati senza rapporto / fabrics are calculated without repeat

cat. B

h 130 → 150 cm / 130 → 150 cm h



228/06 oliva cielo
228/06 olive cielo
COD. TB191



228/05 rubino cielo
228/05 ruby red cielo
COD. TB191



191/06 avio como
191/06 avio blue como
COD. TB185

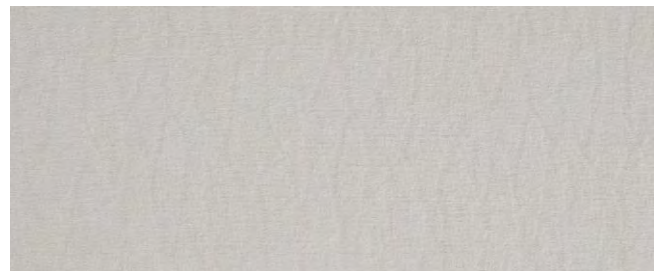

191/01 avorio como
191/01 ivory como
COD. TB182



191/05b grigio como
191/05b grey como
COD. TB186

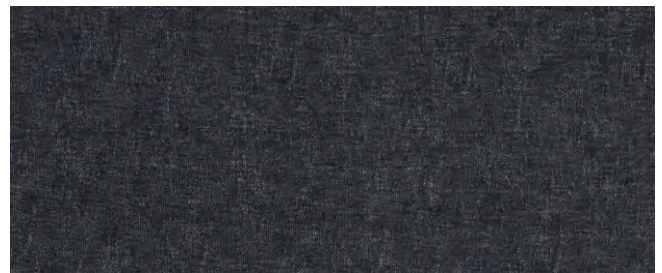

191/10 lavagna como
191/10 slate grey como
COD. TB187



191/02 tortora como
191/02 dove grey como
COD. TB183

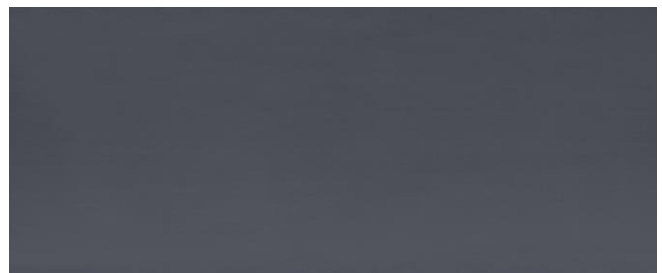

132/0015 avio dolomiti
132/0015 avio blue dolomiti
COD. TB103

N.B.: la riproduzione su materiali diversi può riportare leggere differenze cromatiche rispetto agli originali.

NOTE: slight chromatic differences may result due to reproduction on different materials.

N.B.: i tessuti sono calcolati senza rapporto / fabrics are calculated without repeat

cat. B

h 130 → 150 cm / 130 → 150 cm h

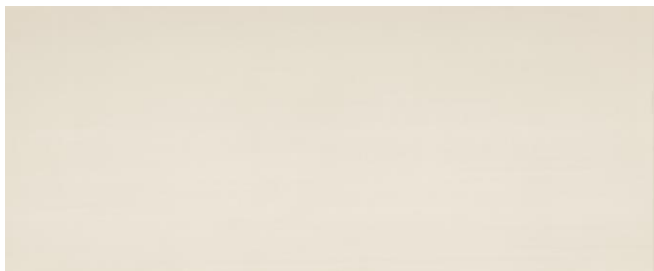

132/0025 avorio dolomiti
132/0025 ivory dolomiti
COD. TB101

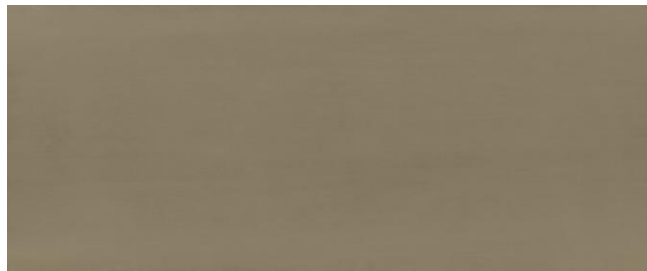

132/0059 bronzo dolomiti
132/0059 bronze dolomiti
COD. TB100

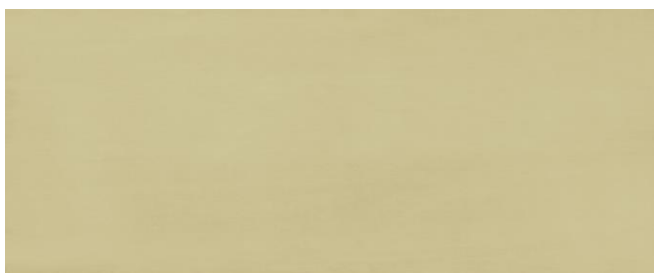

132/0068 cedro dolomiti
132/0068 cedar dolomiti
COD. TB106

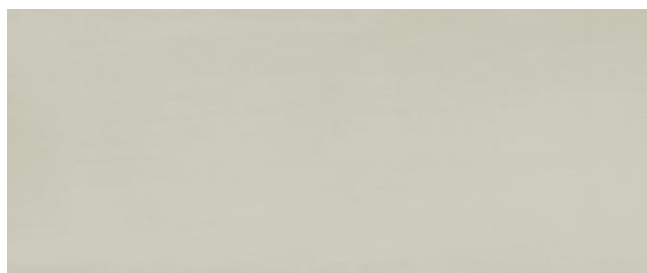

132/0007 ghiaccio dolomiti
132/0007 ice dolomiti
COD. TB099

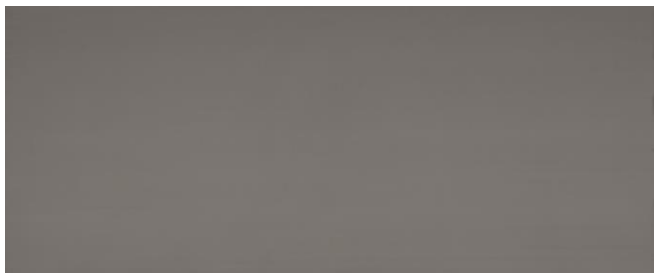

132/0084 grigio dolomiti
132/0084 grey dolomiti
COD. TB104

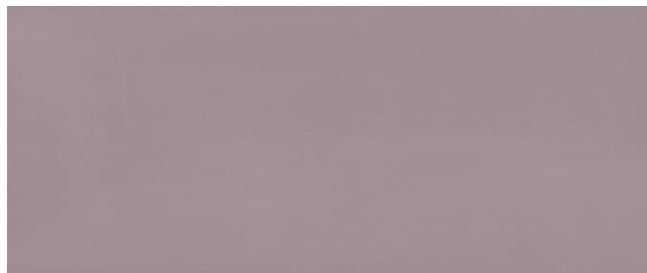

132/0035 lilla dolomiti
132/0035 lilla dolomiti
COD. TB107



132/003 menta dolomiti
132/003 mint green dolomiti
COD. TB102



132/0044 ossido dolomiti
132/0044 oxide orange dolomiti
COD. TB105

N.B.: la riproduzione su materiali diversi può riportare leggere differenze cromatiche rispetto agli originali.

NOTE: slight chromatic differences may result due to reproduction on different materials.

N.B.: i tessuti sono calcolati senza rapporto / fabrics are calculated without repeat

cat. B

h 130 —> 150 cm / 130 —> 150 cm h



132/0028 ottanio dolomiti
132/0028 ottanio dolomiti
COD. TB138

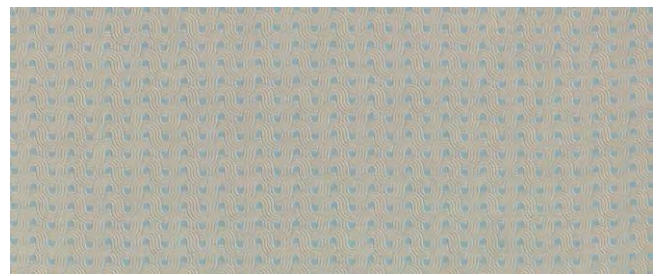

3246/07 acqua jazmin
3246/07 aqua green jazmin
COD. TB033

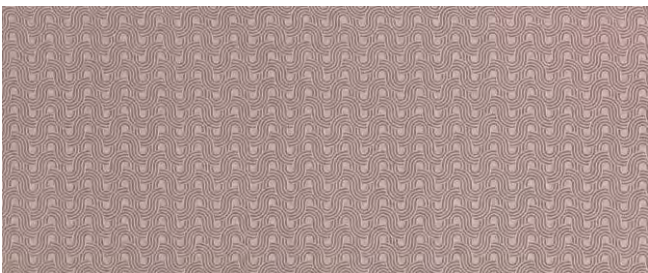

3246/06 lilla jazmin
3246/06 lilla jazmin
COD. TB032

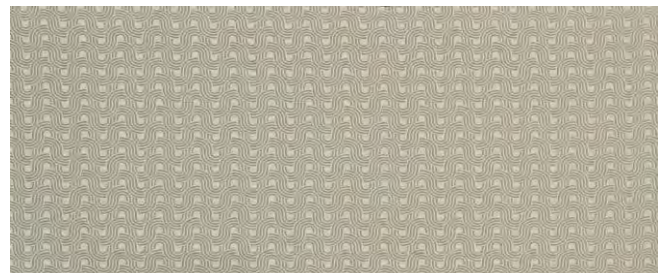

3246/04 oro jazmin
3246/04 gold jazmin
COD. TB031



3246/03 tortora jazmin
3246/03 dove grey jazmin
COD. TB034



19 abete piper
19 pine green piper
COD. TC141

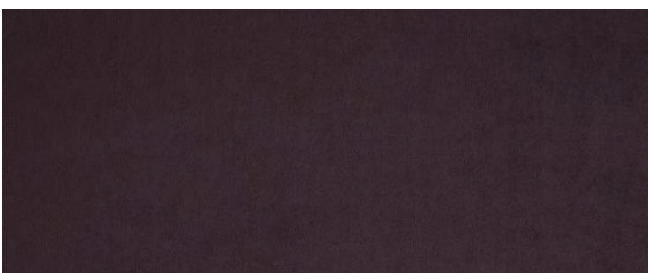

25 prugna piper
25 plum piper
COD. TC142



43 rubino piper
43 ruby red piper
COD. TC143

N.B.: la riproduzione su materiali diversi può riportare leggere differenze cromatiche rispetto agli originali.

NOTE: slight chromatic differences may result due to reproduction on different materials.

N.B.: i tessuti sono calcolati senza rapporto / fabrics are calculated without repeat

cat. B

h 130 → 150 cm / 130 → 150 cm h



69 sabbia piper
69 sand piper
COD. TC146



30060/12 arancio puccini
30060/12 orange puccini
COD. TC113



30060/03 argento puccini
30060/03 silver puccini
COD. TC109



30060/04 argilla puccini
30060/04 clay puccini
COD. TC110



30060/18 avio puccini
30060/18 avio blue puccini
COD. TC115

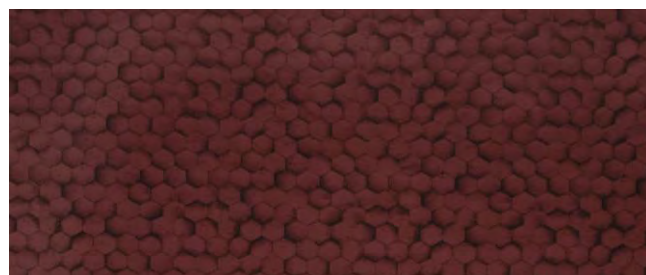

30060/15 bordeaux puccini
30060/15 bordeaux puccini
COD. TC114

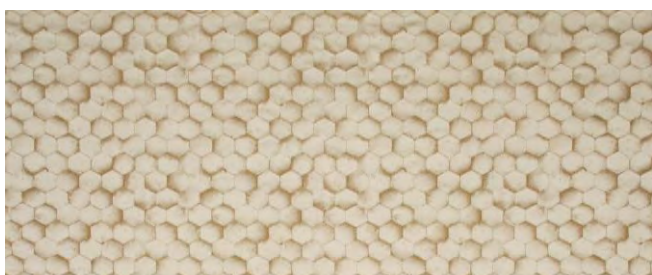

30060/02 corda puccini
30060/02 ecru puccini
COD. TC108



30060/08 ebano puccini
30060/08 ebony puccini
COD. TC111

N.B.: la riproduzione su materiali diversi può riportare leggere differenze cromatiche rispetto agli originali.

NOTE: slight chromatic differences may result due to reproduction on different materials.

N.B.: i tessuti sono calcolati senza rapporto / fabrics are calculated without repeat

cat. B

h 130 —> 150 cm / 130 —> 150 cm h

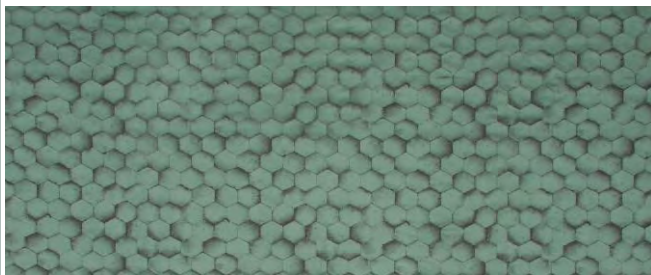

30060/20 lago puccini
30060/20 lake green puccini
COD. TC116

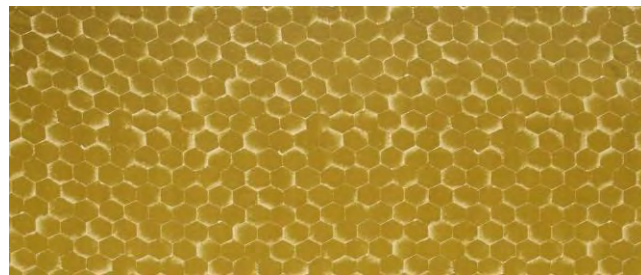

30060/09 oro puccini
30060/09 gold puccini
COD. TC112

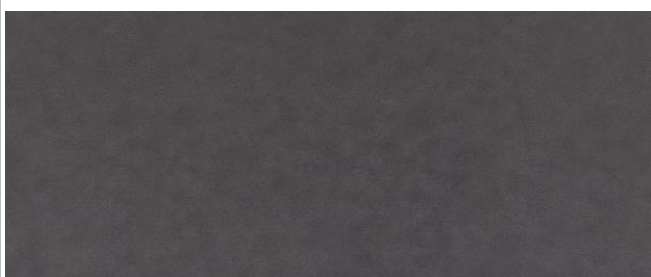

23036/611 antracite "MicroNabuk" sauvage
23036/611 dark grey "MicroNabuk" sauvage
COD. TB112

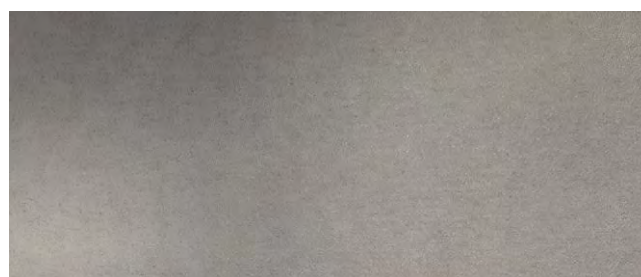

23036/011 beige "MicroNabuk" sauvage
23036/011 beige "MicroNabuk" sauvage
COD. TB137

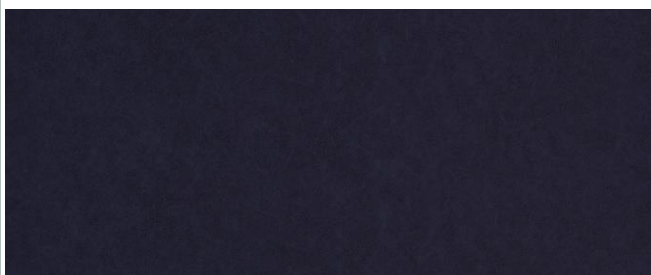

23036/19 blu "MicroNabuk" sauvage
23036/19 blue "MicroNabuk" sauvage
COD. TB140

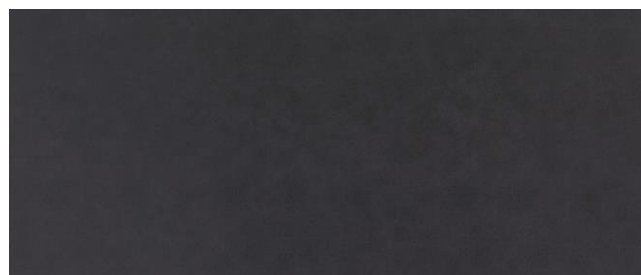

23036/626 grigio "MicroNabuk" sauvage
23036/626 grey "MicroNabuk" sauvage
COD. TB113



23036/200 nero "MicroNabuk" sauvage
23036/200 black "MicroNabuk" sauvage
COD. TB109

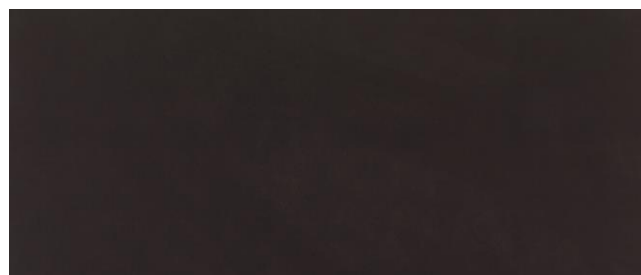

23036/405 testa di moro "MicroNabuk" sauvage
23036/405 testa di moro "MicroNabuk" sauvage
COD. TB110

N.B.: la riproduzione su materiali diversi può riportare leggere differenze cromatiche rispetto agli originali.

NOTE: slight chromatic differences may result due to reproduction on different materials.

N.B.: i tessuti sono calcolati senza rapporto / fabrics are calculated without repeat

cat. B

h 130 → 150 cm / 130 → 150 cm h

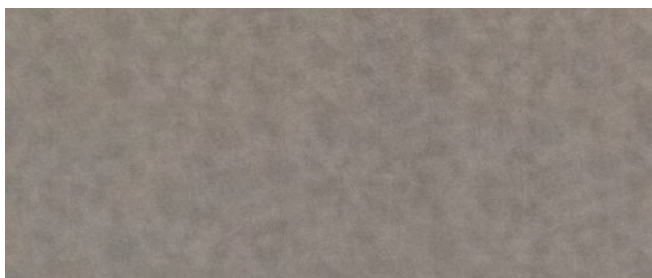

23036/604 tortora "MicroNabuk" sauvage
23036/604 dove grey "MicroNabuk" sauvage
COD. TB111

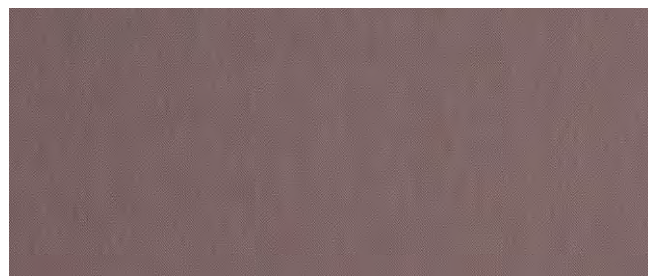

211 bordeaux setting
211 bordeaux setting
COD. TB168



202 grigio setting
202 grey setting
COD. TB164

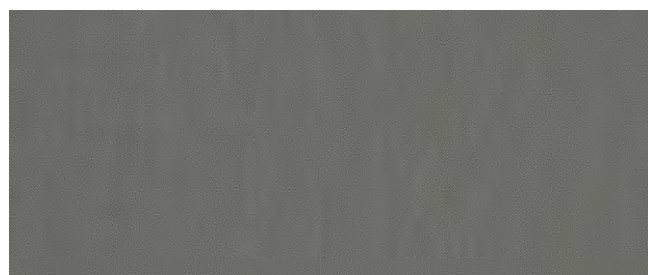

205 oliva setting
205 olive green setting
COD. TB166

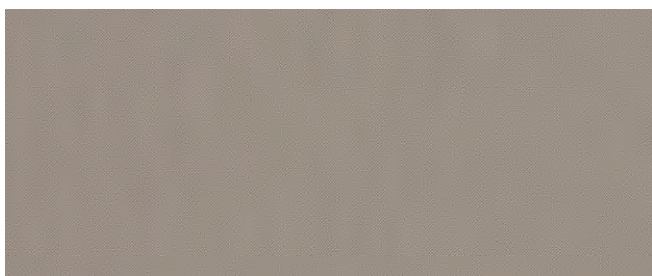

203 sabbia setting
203 sand setting
COD. TB165

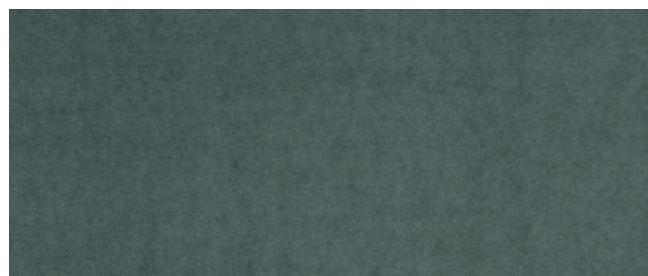

1006 abete snob
1006 pine green snob
COD. TB150

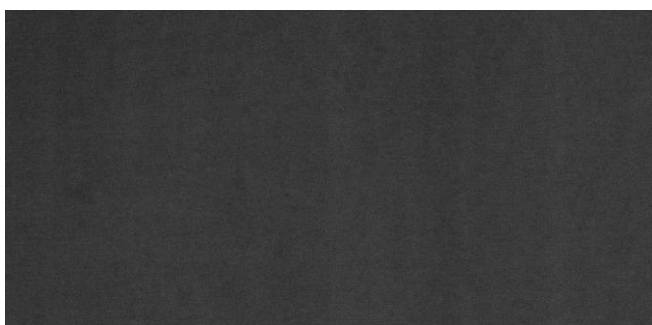

1038 antracite snob
1038 dark grey snob
COD. TB157

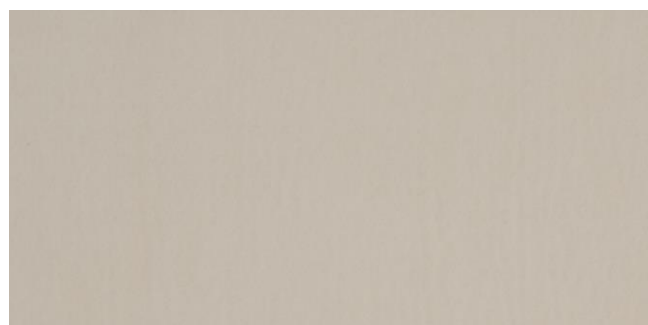

1025 avorio snob
1025 ivory snob
COD. TB155

N.B.: la riproduzione su materiali diversi può riportare leggere differenze cromatiche rispetto agli originali.

NOTE: slight chromatic differences may result due to reproduction on different materials.

N.B.: i tessuti sono calcolati senza rapporto / fabrics are calculated without repeat

cat. B

h 130 → 150 cm / 130 → 150 cm h



1024 beige snob
1024 beige snob
COD. TB154

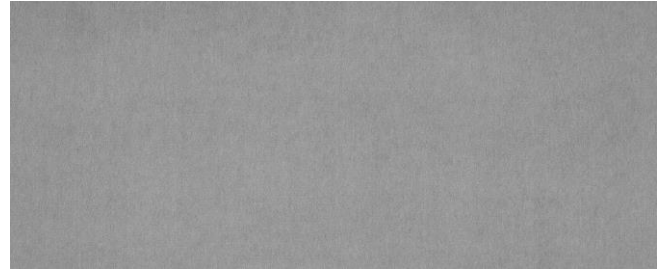

1011 grigio snob
1011 grey snob
COD. TB151



1009 jeans snob
1009 jeans snob
COD. TB149

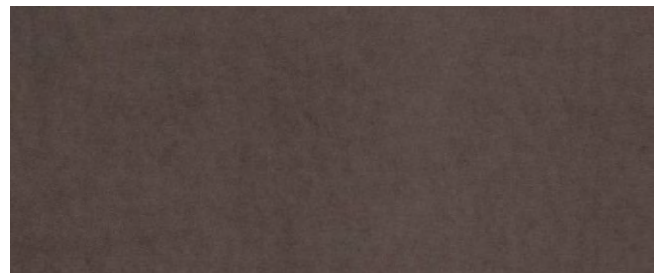

1037 marrone snob
1037 brown snob
COD. TB195

N.B.: la riproduzione su materiali diversi può riportare leggere differenze cromatiche rispetto agli originali.

NOTE: slight chromatic differences may result due to reproduction on different materials.

N.B.: i tessuti sono calcolati senza rapporto / fabrics are calculated without repeat

cat. C

h 130 —> 150 cm / 130 —> 150 cm h



517 antracite ambiente
517 dark grey ambiente
COD. TC155



501 avorio ambiente
501 ivory ambiente
COD. TC150

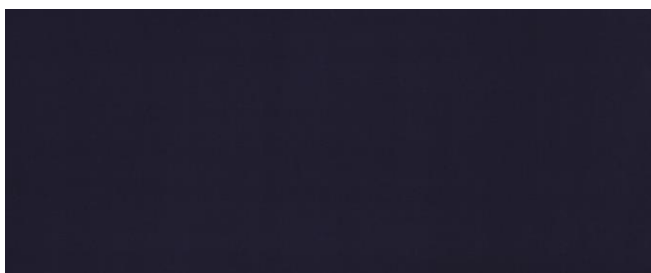

514 blu ambiente
514 blue ambiente
COD. TC154



502 grigio ambiente
502 grey ambiente
COD. TC151



505 oliva ambiente
505 olive green ambiente
COD. TC153



504 tortora ambiente
504 dove grey ambiente
COD. TC152



30082/16 acqua bellini
30082/16 aqua green bellini
COD. TD032



30082/14 ametista bellini
30082/14 amethyst bellini
COD. TD031

N.B.: la riproduzione su materiali diversi può riportare leggere differenze cromatiche rispetto agli originali.

NOTE: slight chromatic differences may result due to reproduction on different materials.

N.B.: i tessuti sono calcolati senza rapporto / fabrics are calculated without repeat

cat. C

h 130 → 150 cm / 130 → 150 cm h



30082/20 ardesia bellini
30082/20 slave brown bellini
COD. TD034

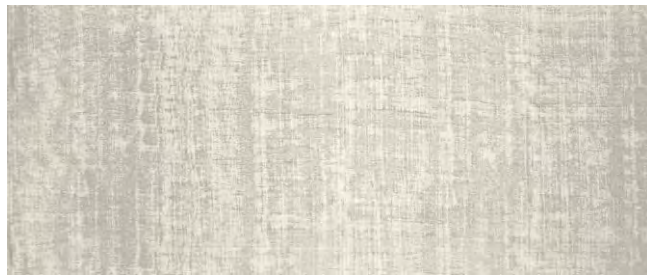

30082/04 argento bellini
30082/04 silver bellini
COD. TD035



30082/06 argilla bellini
30082/06 clay bellini
COD. TD028



30082/13 ossido bellini
30082/13 oxide bellini
COD. TD030



30082/07 piombo bellini
30082/07 lead grey bellini
COD. TD029



046/32 ametista debussy
046/32 amethyst debussy
COD. TD045

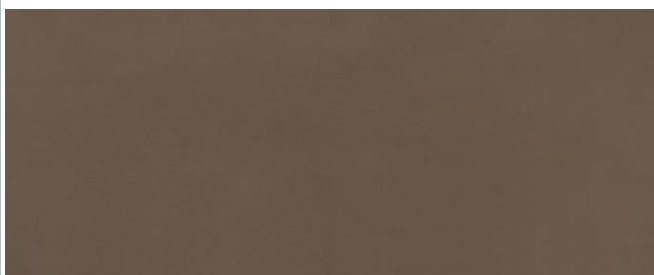

046/62 beige debussy
046/62 beige debussy
COD. TD023

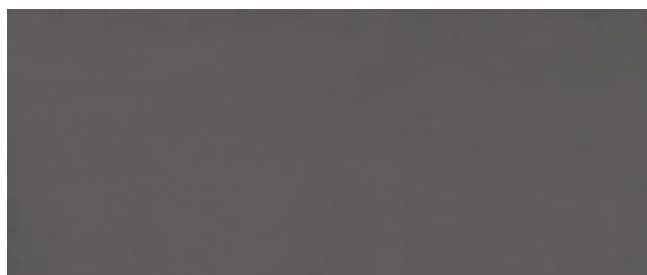

046/63 grigio debussy
046/63 grey debussy
COD. TD022

N.B.: la riproduzione su materiali diversi può riportare leggere differenze cromatiche rispetto agli originali.

NOTE: slight chromatic differences may result due to reproduction on different materials.

N.B.: i tessuti sono calcolati senza rapporto / fabrics are calculated without repeat

cat. C

h 130 → 150 cm / 130 → 150 cm h

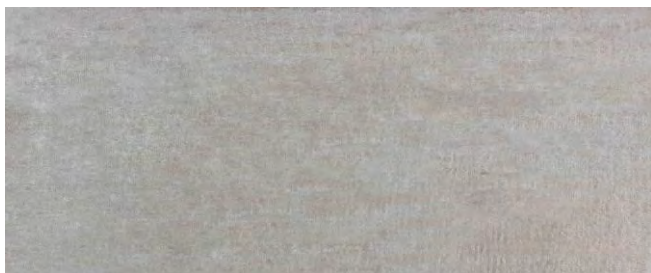

046/30 tortora debussy
046/30 dove grey debussy
COD. TD044



1340/03 beige pirandello
1340/03 beige pirandello
COD. TC126

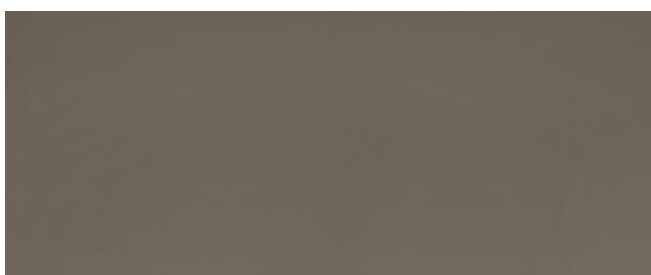

1340/05 fumè pirandello
1340/05 fumè pirandello
COD. TC128



1340/21 grigio pirandello
1340/21 grey pirandello
COD. TC137



1340/15 menta pirandello
1340/15 mint green pirandello
COD. TC130

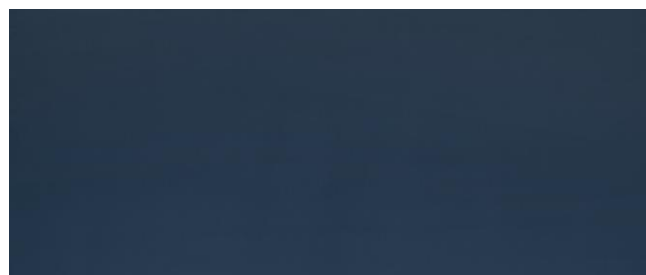

1340/14 oceano pirandello
1340/14 ocean blue pirandello
COD. TC135

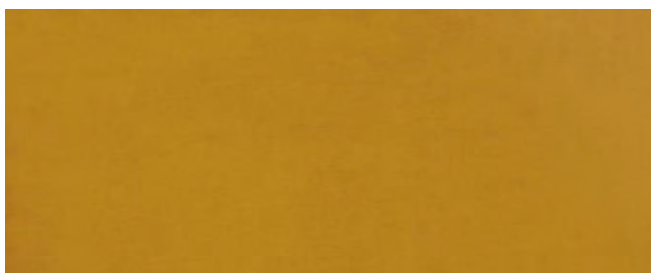

1340/08 oro pirandello
1340/08 gold pirandello
COD. TC133

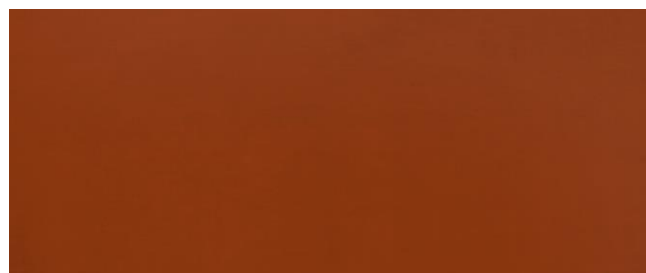

1340/06 ossido pirandello
1340/06 oxide orange pirandello
COD. TC136

N.B.: la riproduzione su materiali diversi può riportare leggere differenze cromatiche rispetto agli originali.

NOTE: slight chromatic differences may result due to reproduction on different materials.

N.B.: i tessuti sono calcolati senza rapporto / fabrics are calculated without repeat

cat. C

h 130 → 150 cm / 130 → 150 cm h



1340/23 ottanio pirandello
1340/23 *ottanio pirandello*
COD. TC134

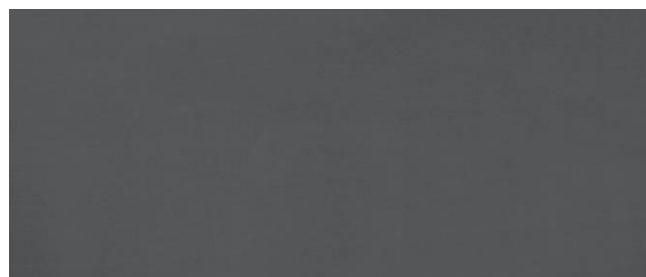

1340/33 piombo pirandello
1340/33 *lead grey pirandello*
COD. TC141



1340/04 tortora pirandello
1340/04 *tortora pirandello*
COD. TC127



1340/18 verde pirandello
1340/18 *green pirandello*
COD. TC138



1340/26 viola pirandello
1340/26 *purple pirandello*
COD. TC131

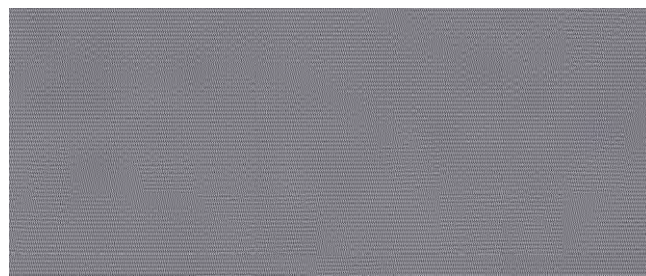

714 blu shade
714 *blue shade*
COD. TC149

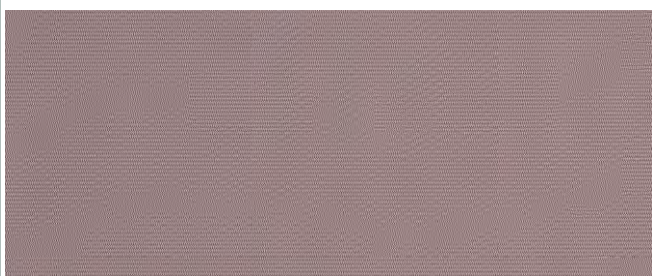

711 bordeaux shade
711 *bordeaux shade*
COD. TC148



701 naturale shade
701 *natural shade*
COD. TC144

N.B.: la riproduzione su materiali diversi può riportare leggere differenze cromatiche rispetto agli originali.

NOTE: slight chromatic differences may result due to reproduction on different materials.

N.B.: i tessuti sono calcolati senza rapporto / fabrics are calculated without repeat

cat. C

h 130 → 150 cm / 130 → 150 cm h

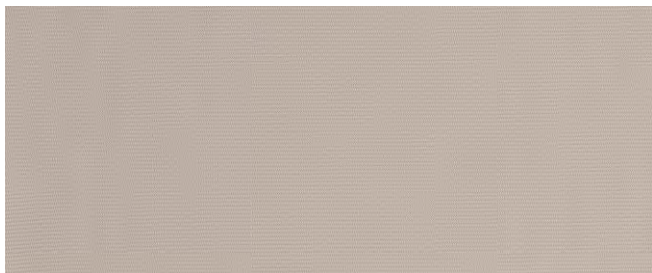

703 sabbia shade
703 sand shade
COD. TC145

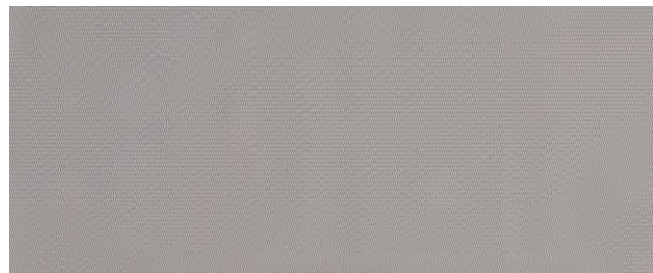

704 tortora shade
704 dove grey shade
COD. TC146



10563/892 avorio snake
10563/892 ivory snake
COD. TC123



10563/587 blu snake
10563/587 blue snake
COD. TC120



10563/385 corallo snake
10563/385 coral red snake
COD. TC118

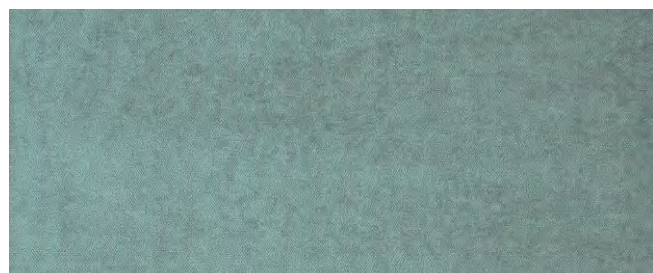

10563/686 menta snake
10563/686 mint green snake
COD. TC124



10563/888 nero snake
10563/888 black snake
COD. TC122



10563/796 oliva snake
10563/796 olive green snake
COD. TC121

N.B.: la riproduzione su materiali diversi può riportare leggere differenze cromatiche rispetto agli originali.

NOTE: slight chromatic differences may result due to reproduction on different materials.

N.B.: i tessuti sono calcolati senza rapporto / fabrics are calculated without repeat

cat. C

h 130 → 150 cm / 130 → 150 cm h

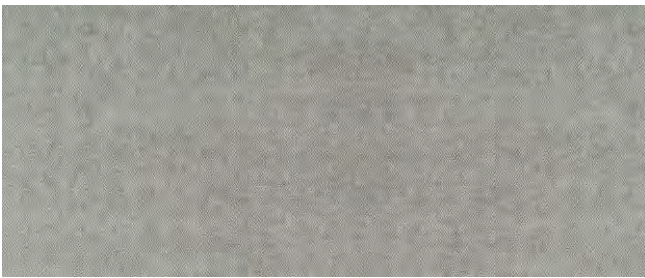

10563/985 ghiaccio snake
10563/985 ice snake
COD. TC125

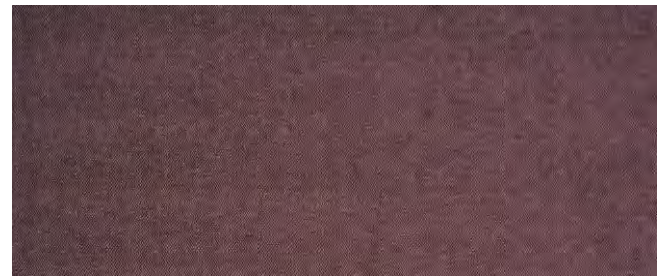

10563/456 viola snake
10563/456 purple snake
COD. TC119



tropic
tropic
COD. TC156



08 blu vamp
08 blue vamp
COD. TC142

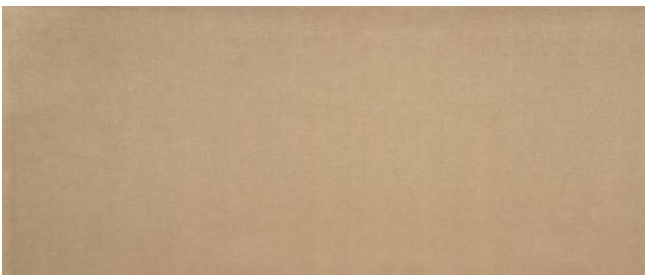

18 oro vecchio vamp
18 antique gold vamp
COD. TC143

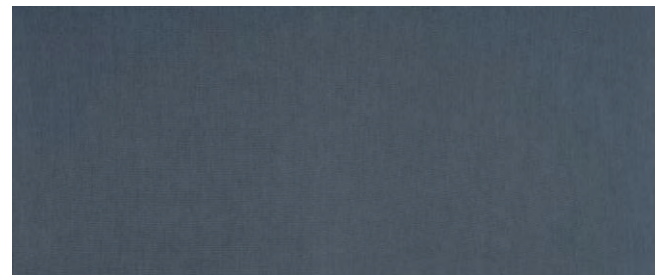

53 blu avio vamp
53 avio blue vamp
COD. TC042



71 tortora vamp
71 dove grey vamp
COD. TC038



80 viola vamp
80 purple vamp
COD. TC035

N.B.: la riproduzione su materiali diversi può riportare leggere differenze cromatiche rispetto agli originali.

NOTE: slight chromatic differences may result due to reproduction on different materials.

N.B.: i tessuti sono calcolati senza rapporto / fabrics are calculated without repeat

cat. C

h 130 → 150 cm / 130 → 150 cm h

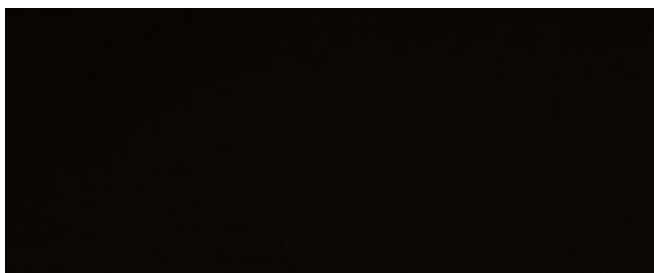

84 marrone vamp
84 brown vamp
COD. TC039

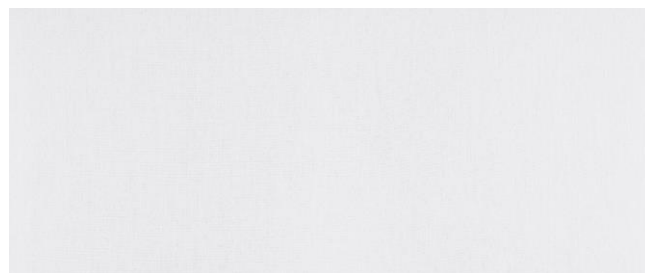

100 bianco vamp
100 white vamp
COD. TC041

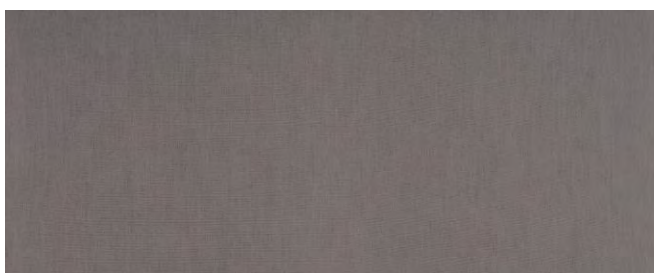

101 grigio vamp
101 grey vamp
COD. TC040



011/7022 antracite vivaldi
011/7022 dark grey vivaldi
COD. TC091



011/7082 arancio vivaldi
011/7082 orange vivaldi
COD. TC107



011/7050 beige vivaldi
011/7050 beige vivaldi
COD. TC103



011/7061 ebano vivaldi
011/7061 ebony vivaldi
COD. TC105



011/7077 grigio vivaldi
011/7077 grey vivaldi
COD. TC092

N.B.: la riproduzione su materiali diversi può riportare leggere differenze cromatiche rispetto agli originali.

NOTE: slight chromatic differences may result due to reproduction on different materials.

N.B.: i tessuti sono calcolati senza rapporto / *fabrics are calculated without repeat*

cat. C

h 130 → 150 cm / 130 → 150 cm h

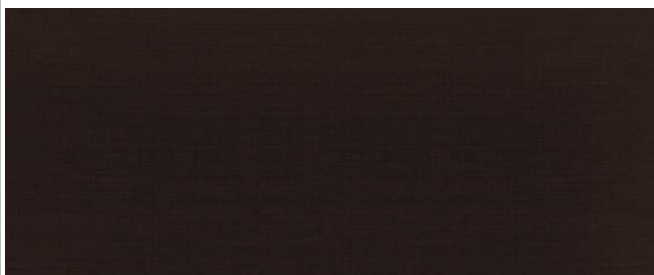

011/6020 marrone vivaldi
011/6020 brown vivaldi
COD. TC096



011/7020 muschio vivaldi
011/7020 moss green vivaldi
COD. TC102

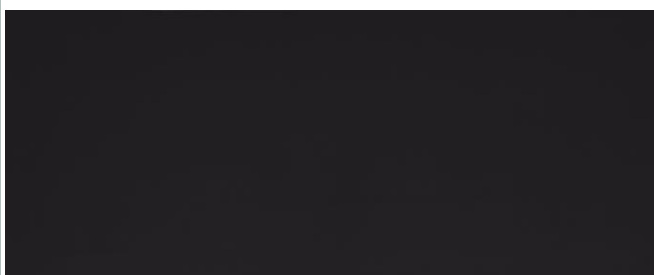

011/5022 nero vivaldi
011/5022 black vivaldi
COD. TC095

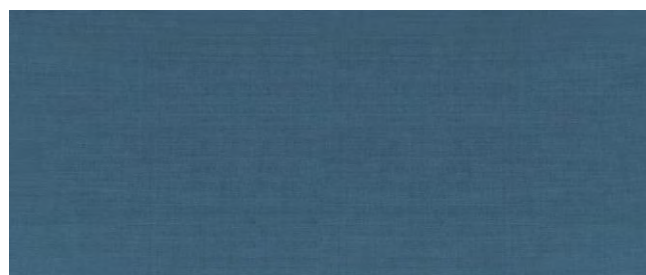

011/7066 oceano vivaldi
011/7066 blue ocean vivaldi
COD. TC106



011/5006 oliva vivaldi
011/5006 olive green vivaldi
COD. TC093

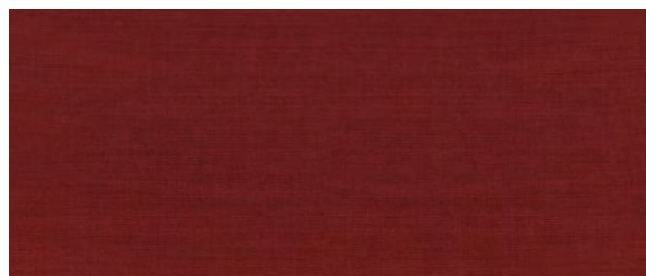

011/5019 rosso vivaldi
011/5019 red vivaldi
COD. TC094



011/6046 taupe vivaldi
011/6046 taupe vivaldi
COD. TC097



011/7053 tortora vivaldi
011/7053 dove grey vivaldi
COD. TC104

N.B.: la riproduzione su materiali diversi può riportare leggere differenze cromatiche rispetto agli originali.

NOTE: slight chromatic differences may result due to reproduction on different materials.

N.B.: i tessuti sono calcolati senza rapporto / fabrics are calculated without repeat

cat. D

h 130 —> 150 cm / 130 —> 150 cm h

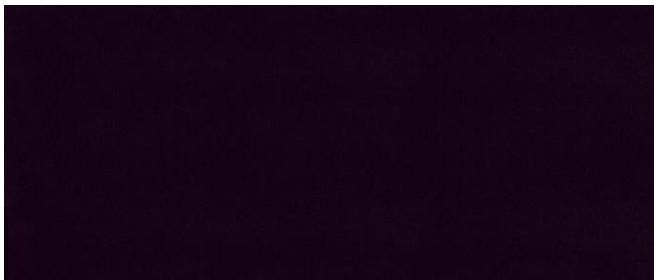

2220/50 viola angelico
2220/50 purple angelico
COD. TD010

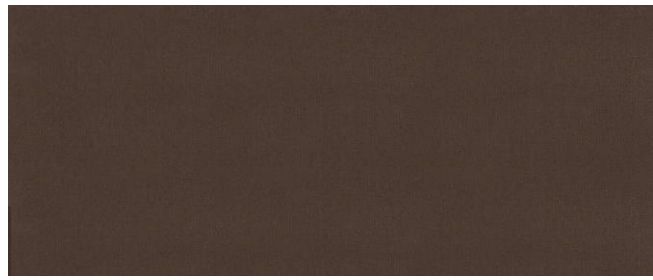

2220/59 fumé angelico
2220/59 fumé angelico
COD. TD011

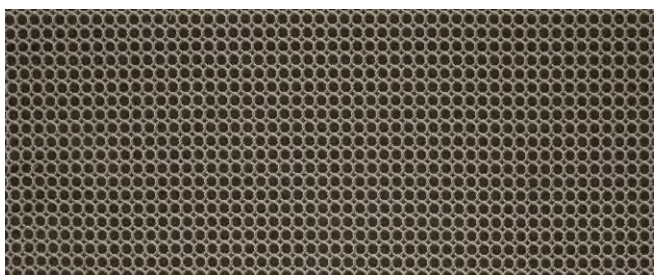

10594/999 antracite chopin
10594/999 dark grey chopin
COD. TD040

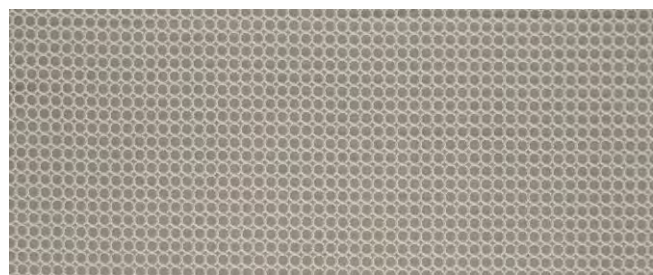

10594/997 grigio chopin
10594/997 grey chopin
COD. TD039

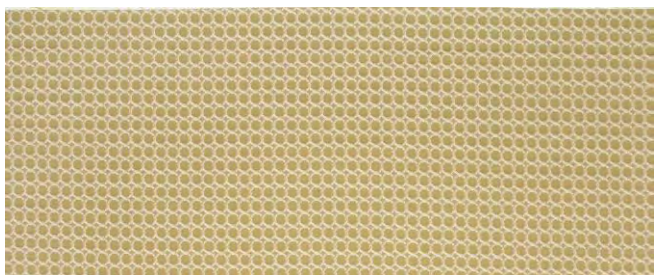

10594/786 oro chopin
10594/786 gold chopin
COD. TD037



012/7022 grigio diamante
012/7022 grey diamant
COD. TD020

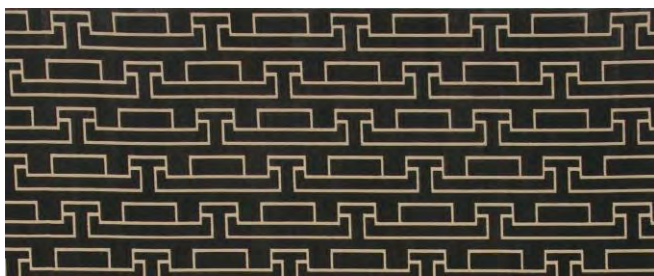

024/0001 grigio labyrinth
024/0001 grey labyrinth
COD. TD018

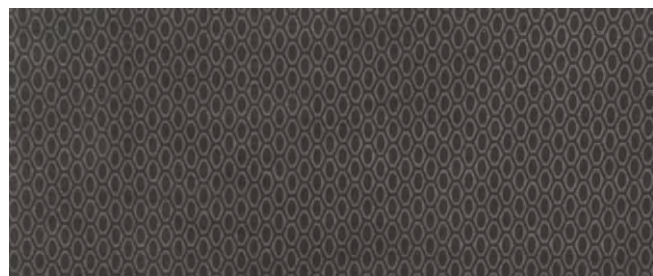

014/7022 grigio miel
014/7022 grey miel
COD. TD021

N.B.: la riproduzione su materiali diversi può riportare leggere differenze cromatiche rispetto agli originali.

NOTE: slight chromatic differences may result due to reproduction on different materials.

N.B.: i tessuti sono calcolati senza rapporto / fabrics are calculated without repeat

cat. D

h 130 → 150 cm / 130 → 150 cm h



013/7022 grigio troy
013/7022 grey troy
COD. TD019

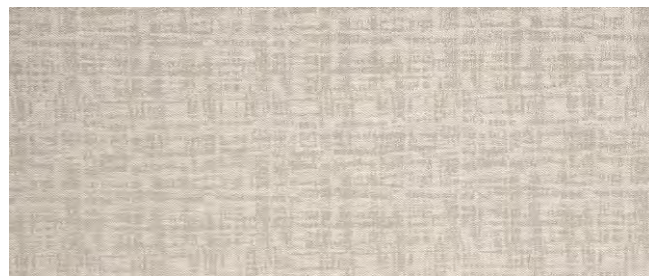

10612/995 avorio verdi
10612/995 ivory verdi
COD. TD042



10612/884 beige verdi
10612/884 beige verdi
COD. TD041

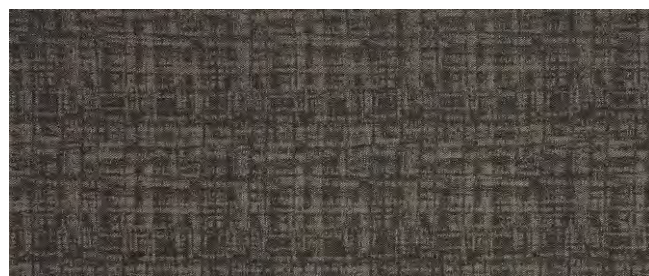

10612/998 nero verdi
10612/998 black verdi
COD. TD043

N.B.: la riproduzione su materiali diversi può riportare leggere differenze cromatiche rispetto agli originali.

NOTE: slight chromatic differences may result due to reproduction on different materials.

N.B.: i tessuti sono calcolati senza rapporto / fabrics are calculated without repeat

cat. E

h 130 → 150 cm / 130 → 150 cm h

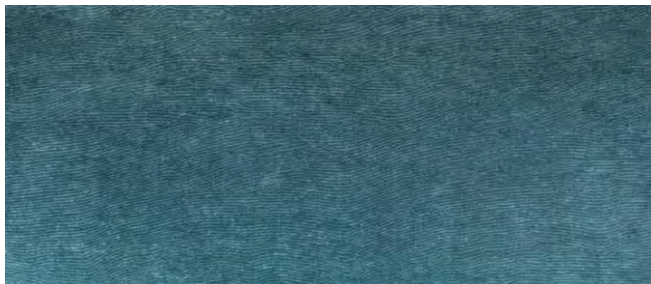

4101/43 ottanio bach
4101/43 *ottanio bach*
COD. TE015

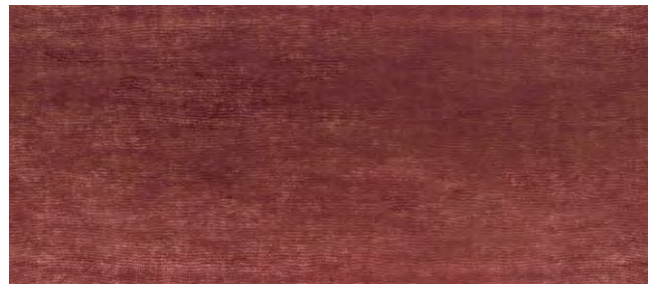

4101/63 corallo bach
4101/63 *coral red bach*
COD. TE016

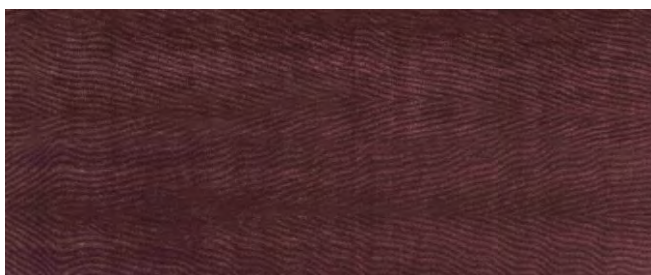

4101/65 lampone bach
4101/43 *raspberry bach*
COD. TE017

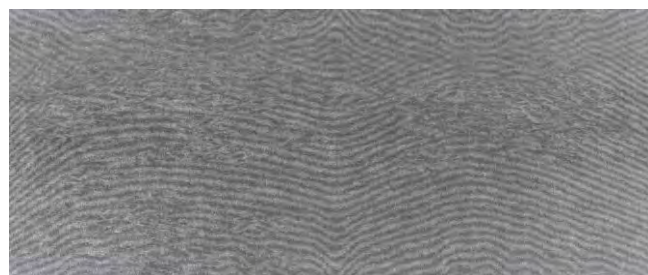

4101/74 tortora bach
4101/74 *dove grey bach*
COD. TE018

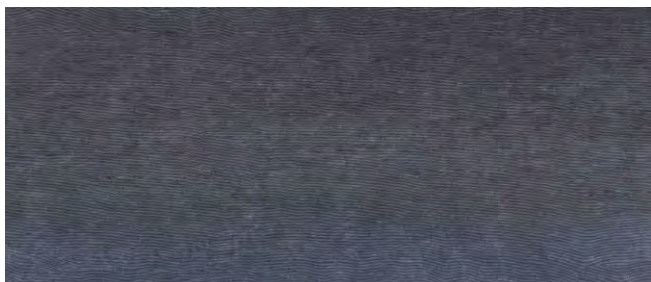

4101/77 grigio bach
4101/77 *grey bach*
COD. TE019



0144/01 grigio bouquet
0144/01 *grey bouquet*
COD. TE013



0144/02 verde bouquet
0144/02 *green bouquet*
COD. TE014



10423/993 beige madrid
10423/993 *beige madrid*
COD. TF032

N.B.: la riproduzione su materiali diversi può riportare leggere differenze cromatiche rispetto agli originali.

NOTE: slight chromatic differences may result due to reproduction on different materials.

N.B.: i tessuti sono calcolati senza rapporto / fabrics are calculated without repeat

cat. E

h 130 → 150 cm / 130 → 150 cm h



10423/588 blu madrid
10423/588 blue madrid
COD. TF029



10423/387 rosso madrid
10423/387 red madrid
COD. TF027



10423/683 sabbia madrid
10423/683 sand madrid
COD. TF030



10423/896 taupe madrid
10423/896 taupe madrid
COD. TF031

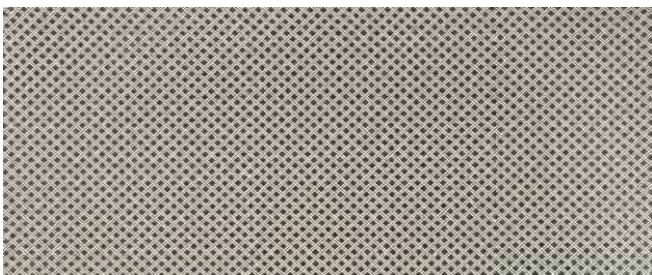

0202/005 antracite rossini
0202/005 dark grey rossini
COD. TE003



0202/004 taupe rossini
0202/004 taupe rossini
COD. TE002

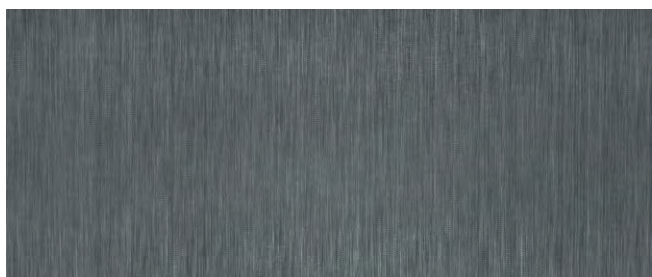

10572/998 antracite wagner
10572/998 dark grey wagner
COD. TE012



10572/982 avorio wagner
10572/982 ivory wagner
COD. TE011

N.B.: la riproduzione su materiali diversi può riportare leggere differenze cromatiche rispetto agli originali.

NOTE: slight chromatic differences may result due to reproduction on different materials.

N.B.: i tessuti sono calcolati senza rapporto / fabrics are calculated without repeat

cat. E

h 130 → 150 cm / 130 → 150 cm h

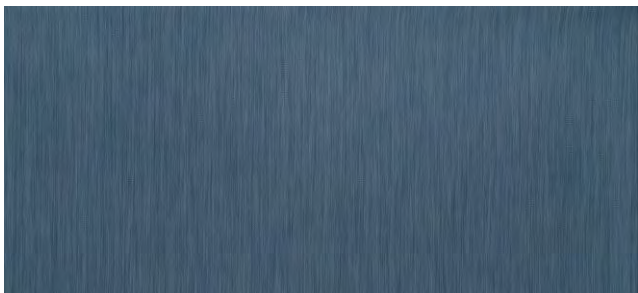

10572/556 blu wagner
10572/556 blue wagner
COD. TE007

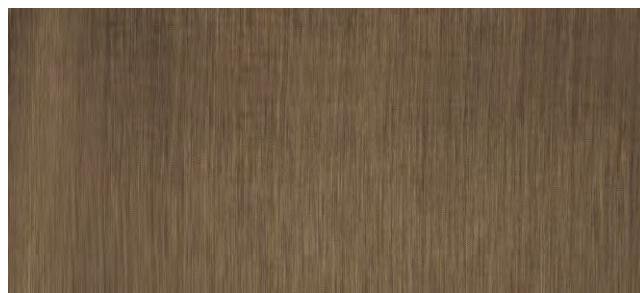

10572/886 bronzo wagner
10572/886 bronze wagner
COD. TE010

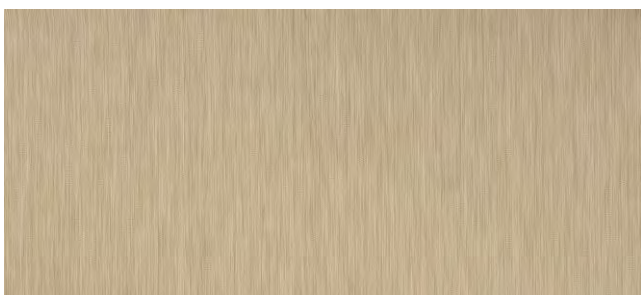

10572/883 oro wagner
10572/883 gold wagner
COD. TE009



10572/335 rosso wagner
10572/335 red wagner
COD. TE004

N.B.: la riproduzione su materiali diversi può riportare leggere differenze cromatiche rispetto agli originali.

NOTE: slight chromatic differences may result due to reproduction on different materials.

N.B.: i tessuti sono calcolati senza rapporto / fabrics are calculated without repeat

cat. F

h 130 → 150 cm / 130 → 150 cm h

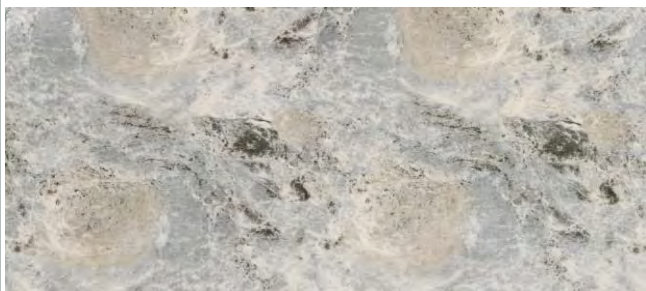

6830/03 mare dione
6830/03 blue sea dione
COD. TF033



14037/004 antracite lucrezia
14037/004 dark grey lucrezia
COD. TF013



14037/001 avorio lucrezia
14037/001 ivory lucrezia
COD. TF014



0049/029 beige space
0049/029 beige space
COD. TF019

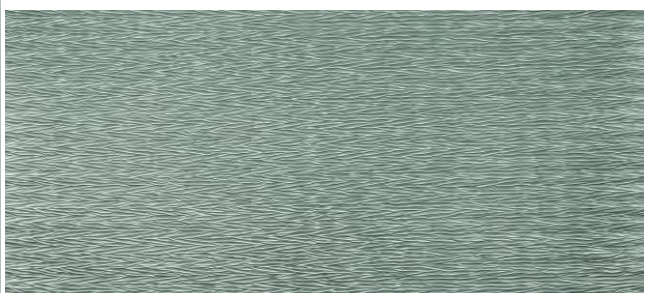

0049/103 menta space
0049/103 mint green space
COD. TF020



0049/940 oliva space
0049/940 olive green space
COD. TF021

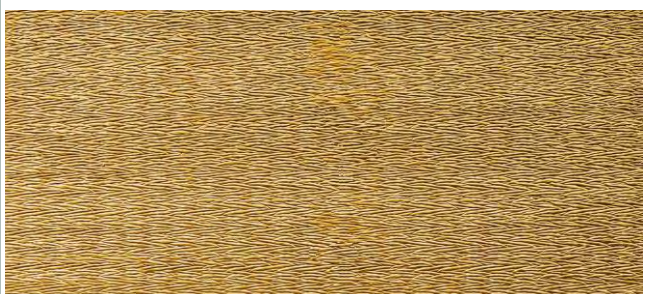

0049/18 oro space
0049/18 gold space
COD. TF022



0049/36 piombo space
0049/36 lead grey space
COD. TF024

N.B.: la riproduzione su materiali diversi può riportare leggere differenze cromatiche rispetto agli originali.

NOTE: slight chromatic differences may result due to reproduction on different materials.

N.B.: i tessuti sono calcolati senza rapporto / fabrics are calculated without repeat

cat. F

h 130 —> 150 cm / 130 —> 150 cm h

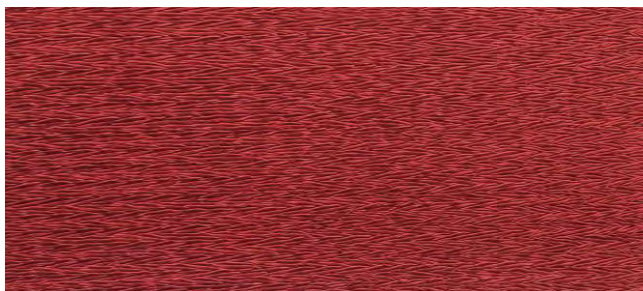

0049/32 rosso space
0049/32 red space
COD. TF023

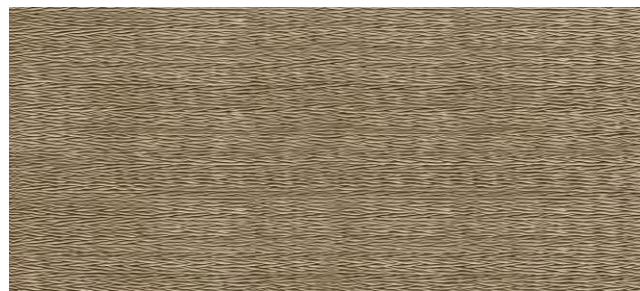

0049/34 taupe space
0049/34 taupe space
COD. TF025



4311/05 acqua tartuffe
4311/05 aqua green tartuffe
COD. TF034



4311/03 beige tartuffe
4311/03 beige tartuffe
COD. TF035



4311/01 corallo tartuffe
4311/01 coral red tartuffe
COD. TF036



4311/02 grigio tartuffe
4311/02 grey tartuffe
COD. TF037

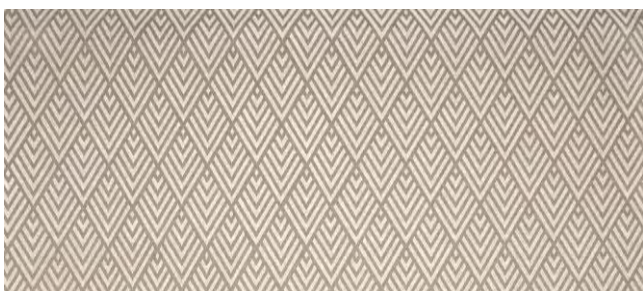

14032/002 beige toledo
14032/002 beige toledo
COD. TF016

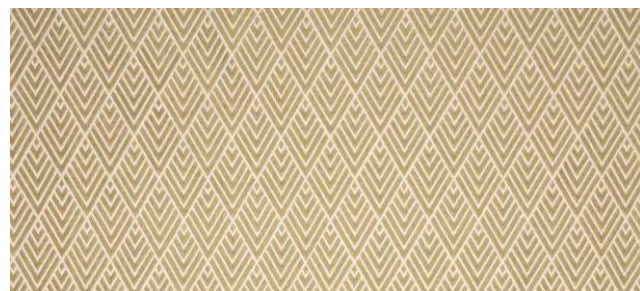

14032/003 camel toledo
14032/003 camel toledo
COD. TF018

N.B.: la riproduzione su materiali diversi può riportare leggere differenze cromatiche rispetto agli originali.

NOTE: slight chromatic differences may result due to reproduction on different materials.

N.B.: i tessuti sono calcolati senza rapporto / fabrics are calculated without repeat

cat. G

h 130 → 150 cm / 130 → 150 cm h



4210/01 argento bargelo
4210/01 silver bargelo
COD. TG016



4210/03 cielo bargelo
4210/03 blue sky bargelo
COD. TG017

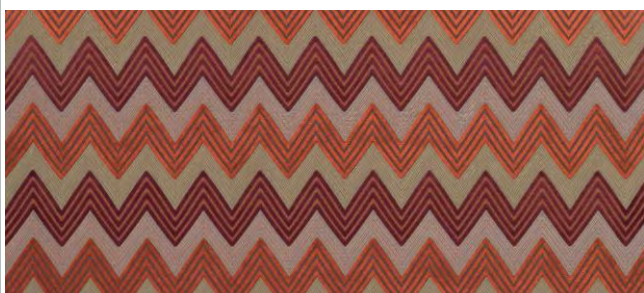

4210/05 rosso bargelo
4210/05 red bargelo
COD. TG018



14025/003 cedro stradivari
14025/003 yellow cedar stradivari
COD. TG011

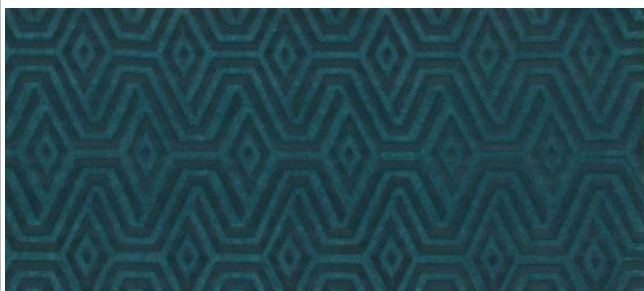

14025/002 ottanio stradivari
14025/002 ottanio stradivari
COD. TG012

N.B.: la riproduzione su materiali diversi può riportare leggere differenze cromatiche rispetto agli originali.

NOTE: slight chromatic differences may result due to reproduction on different materials.

N.B.: i tessuti sono calcolati senza rapporto / fabrics are calculated without repeat

cat. LUX

h 130 → 150 cm / 130 → 150 cm h

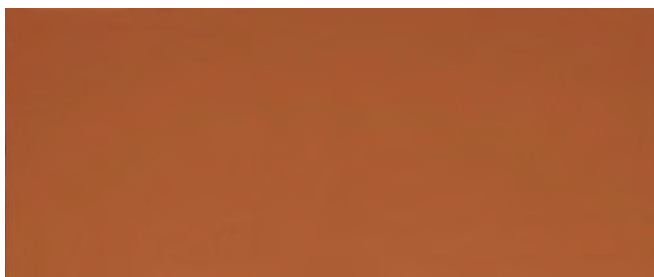

30057/13 arancio casanova
30057/13 orange casanova
COD. TL007



30057/17 cardinale casanova
30057/17 cardinal red casanova
COD. TL010



30057/07 fumo casanova
30057/07 smoke grey casanova
COD. TL003



30057/14 lampone casanova
30057/14 raspberry casanova
COD. TL008



30057/19 marrone casanova
30057/19 brown casanova
COD. TL012



30057/18 oro casanova
30057/18 gold casanova
COD. TL011

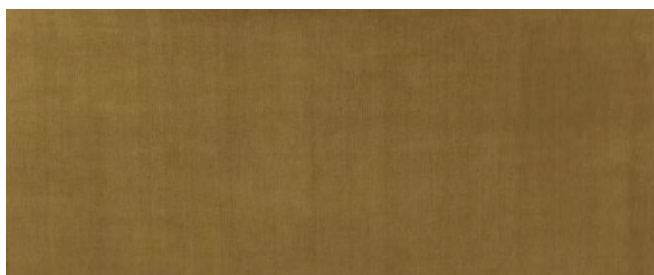

30057/08 oro vecchio casanova
30057/08 antique gold casanova
COD. TL004

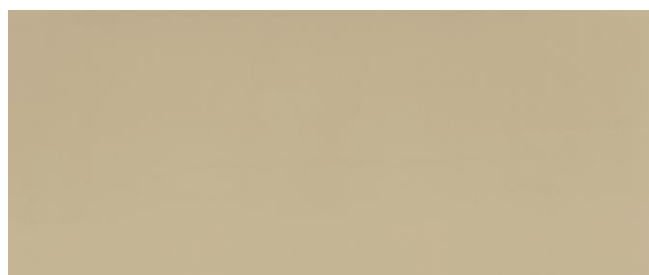

30057/02 sabbia casanova
30057/02 sand casanova
COD. TL001

N.B.: la riproduzione su materiali diversi può riportare leggere differenze cromatiche rispetto agli originali.

NOTE: slight chromatic differences may result due to reproduction on different materials.

N.B.: i tessuti sono calcolati senza rapporto / fabrics are calculated without repeat

cat. LUX

h 130 —> 150 cm / 130 —> 150 cm h

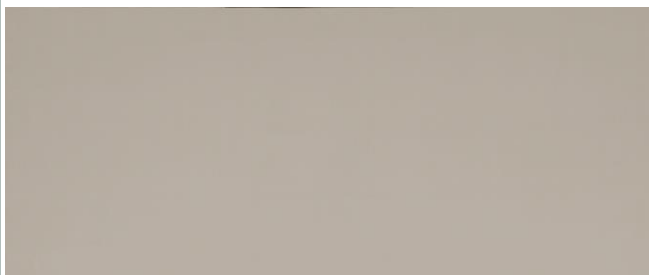

30057/03 tortora casanova
30057/03 dove grey casanova
COD. TL002

N.B.: la riproduzione su materiali diversi può riportare leggere differenze cromatiche rispetto agli originali.

NOTE: slight chromatic differences may result due to reproduction on different materials.

N.B.: i tessuti sono calcolati senza rapporto / *fabrics are calculated without repeat*

wengè | *wengè*

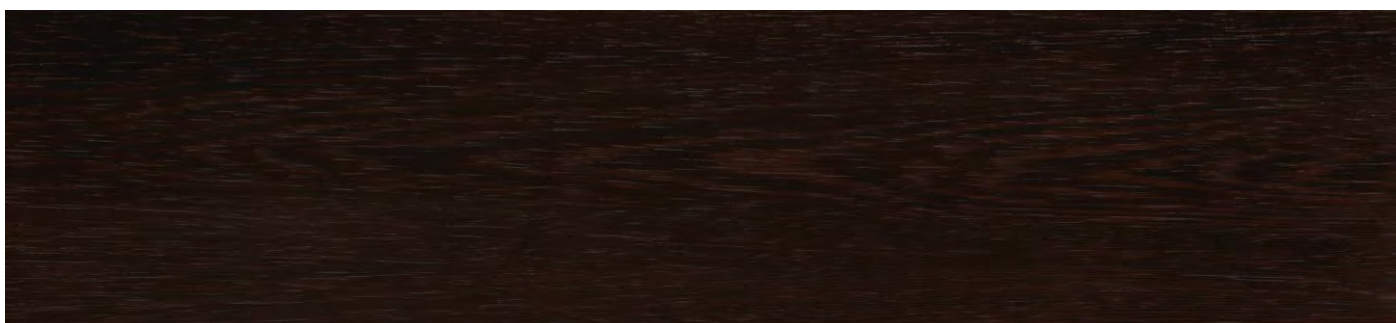

palissandro opaco | *matt rosewood*



palissandro lucido | *polish rosewood*

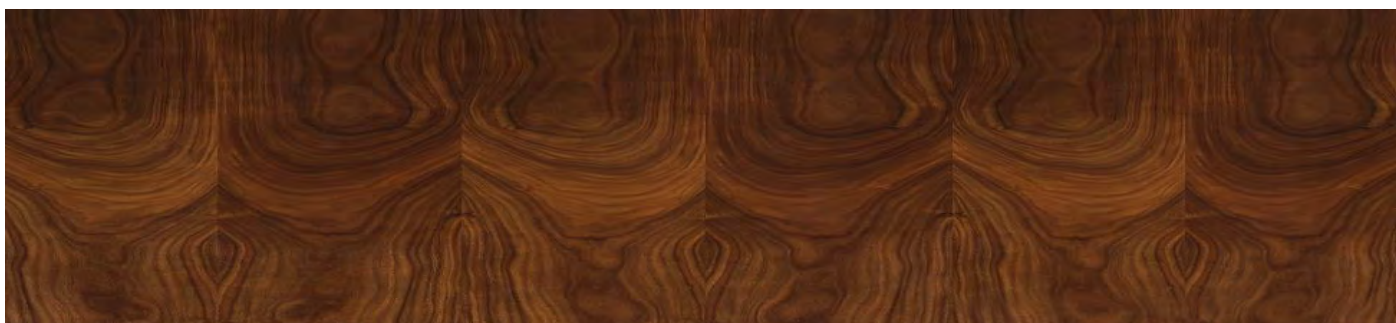

palissandro tabacco opaco | *tobacco matt rosewood*

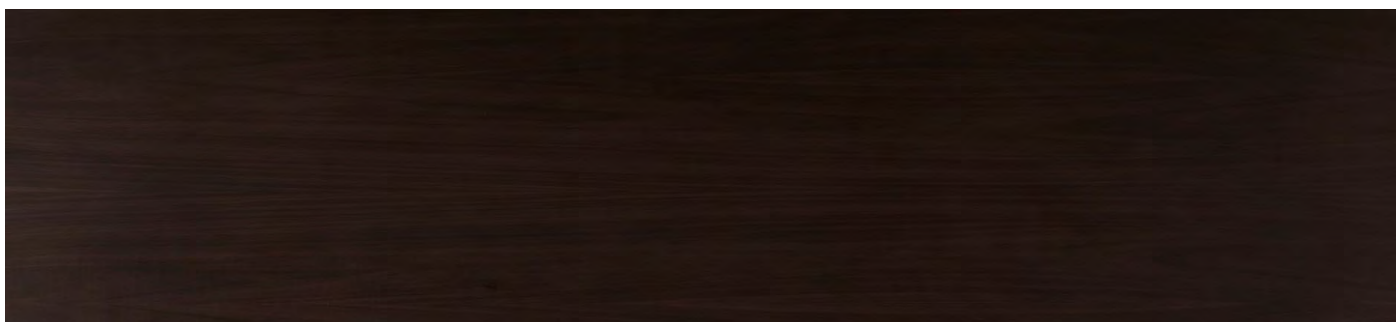

palissandro tabacco lucido | *polish tobacco rosewood*

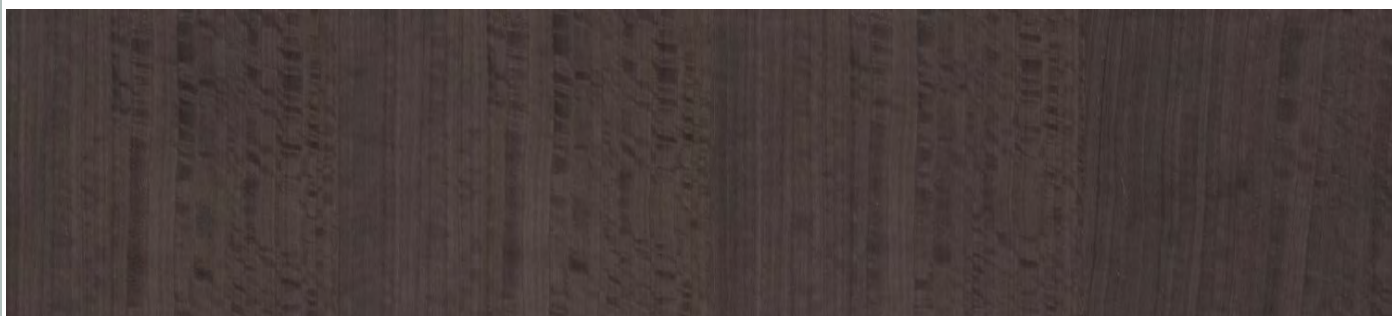
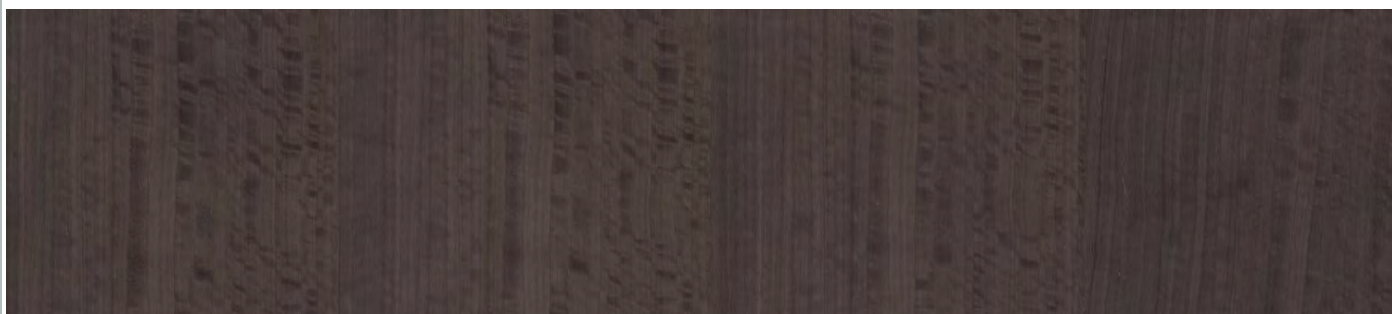
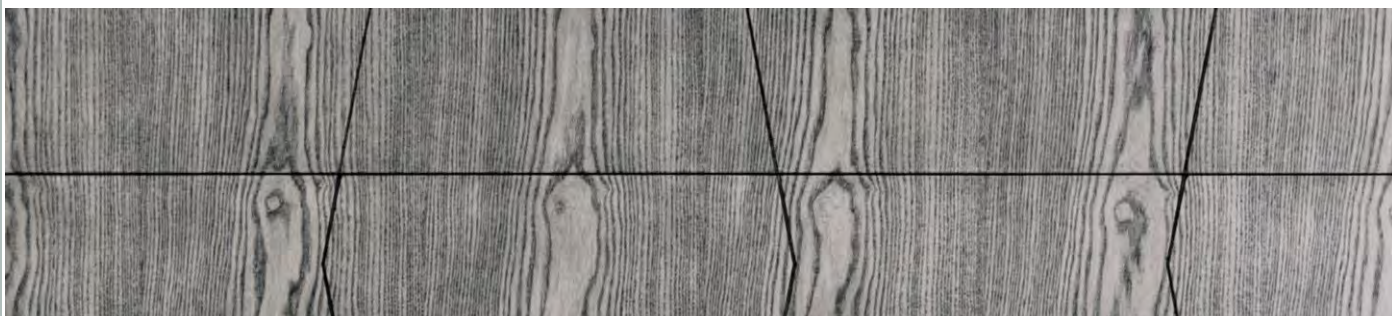

N.B.: la riproduzione su materiali diversi può riportare leggere differenze cromatiche rispetto agli originali.
NOTE: slight chromatic differences may result due to reproduction on different materials.

eucalipto frisè grigio opaco | *matt grey frisè eucalyph***eucalipto frisè grigio lucido | *polish grey frisè eucalyph*****noce canaletto frisè opaco | *matt canaletto frisè walnut*****noce canaletto frisè lucido | *polish canaletto frisè walnut*****frassino grigio | *grey ashwood***

N.B.: la riproduzione su materiali diversi può riportare leggere differenze cromatiche rispetto agli originali.
NOTE: slight chromatic differences may result due to reproduction on different materials.

piuma di noce | *burr walnut*

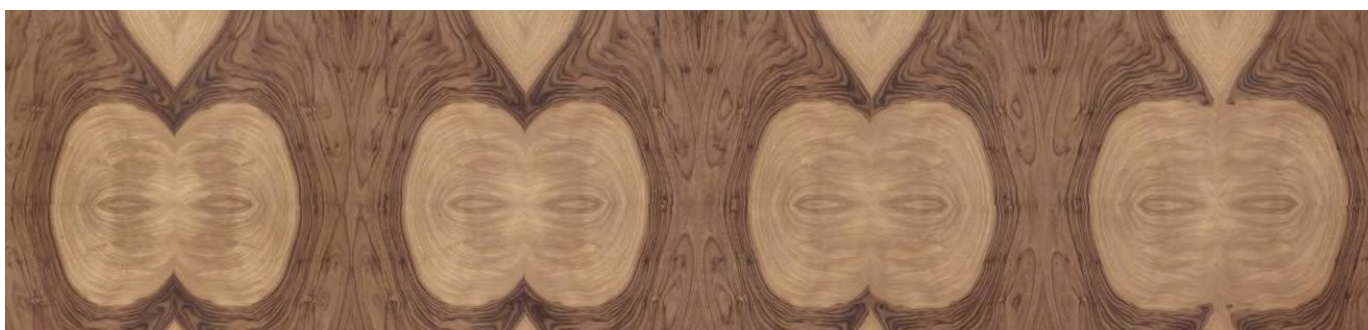

piuma di noce grigia | *grey burr walnut*

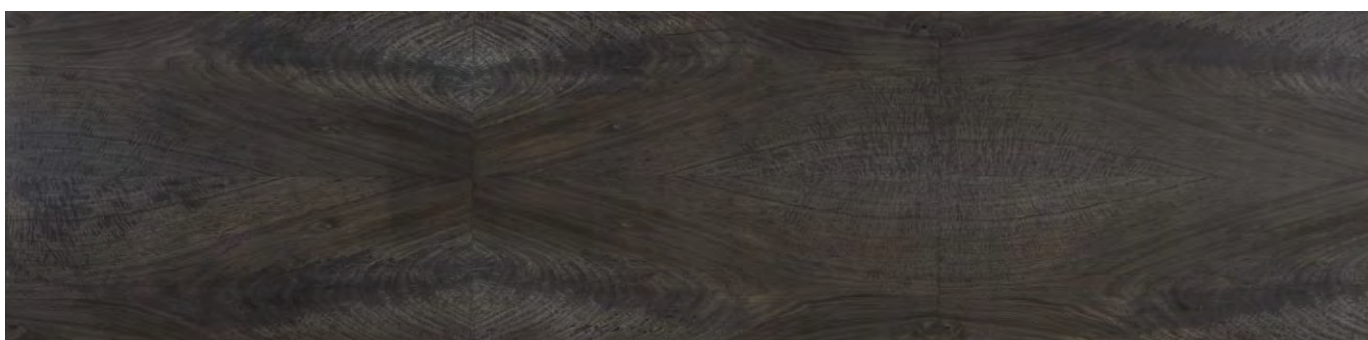

frassino beige | *beige ashwood - SMANIA NEST*

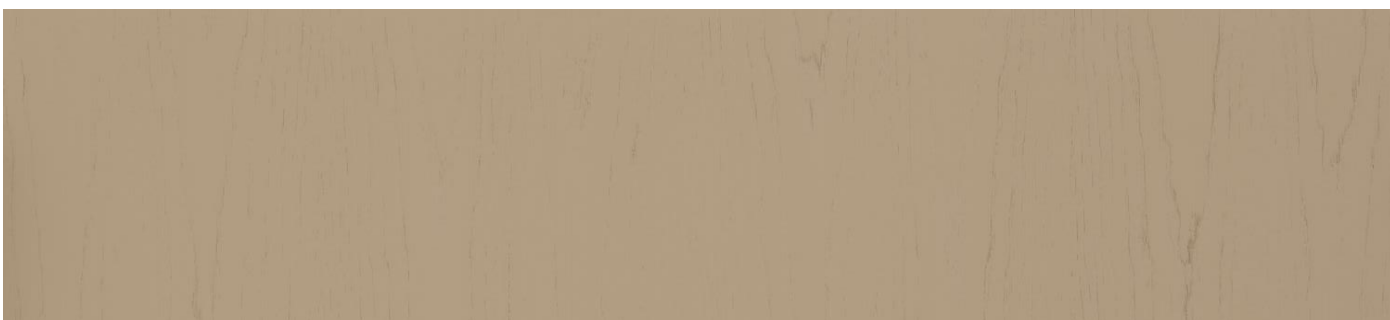

frassino blu | *blue ashwood - SMANIA NEST*

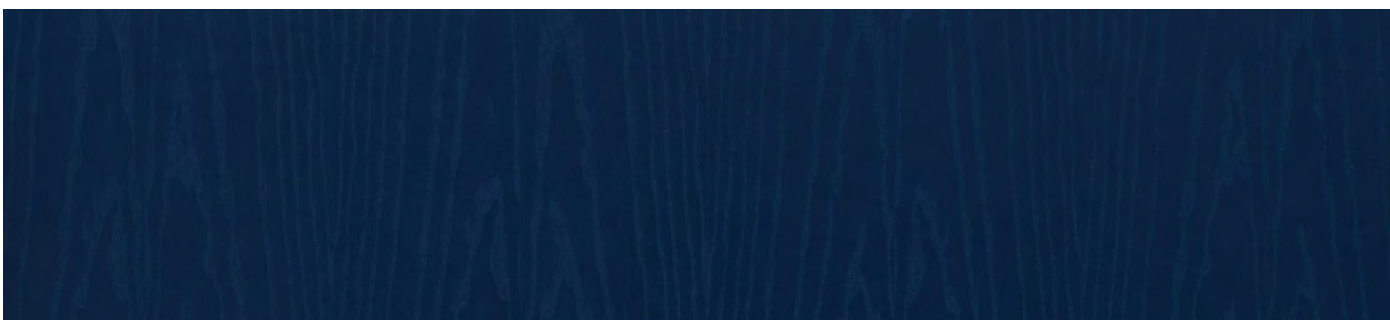

frassino bordeaux | *bordeaux ashwood - SMANIA NEST*

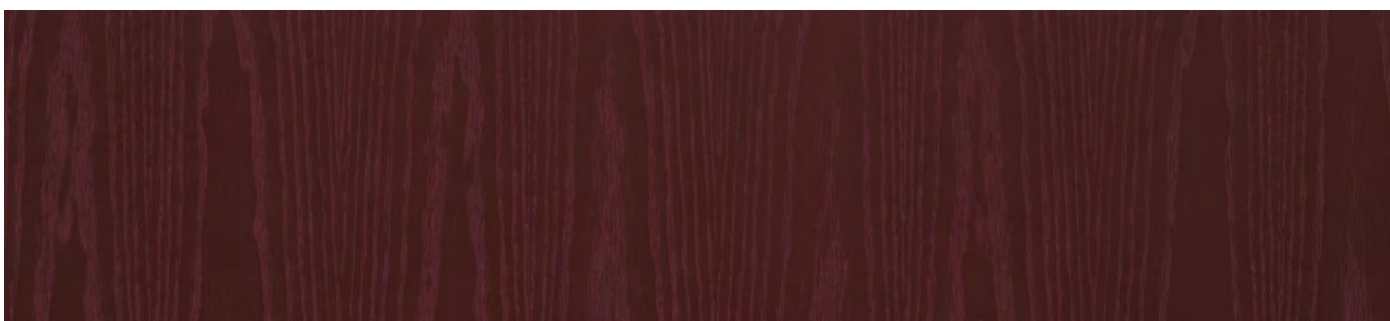

frassino grigio | *grey ashwood - SMANIA NEST*

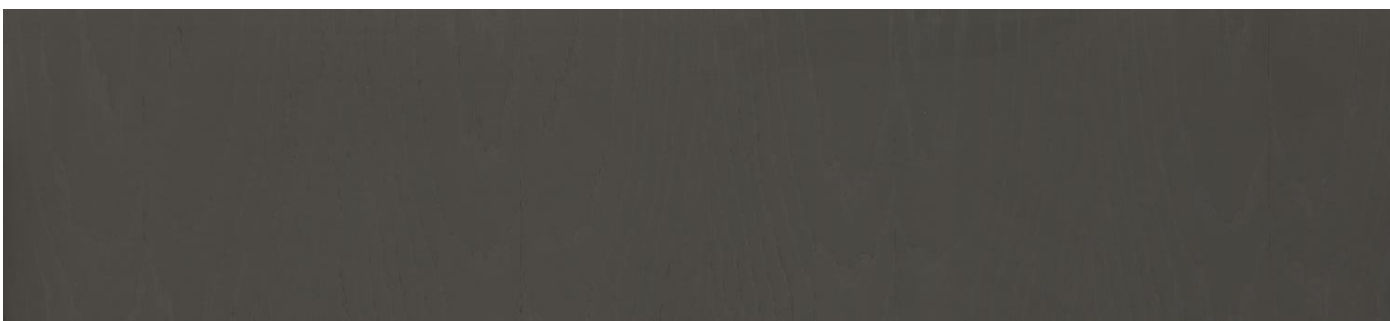

frassino grigio seta | *silk grey ashwood - SMANIA NEST*

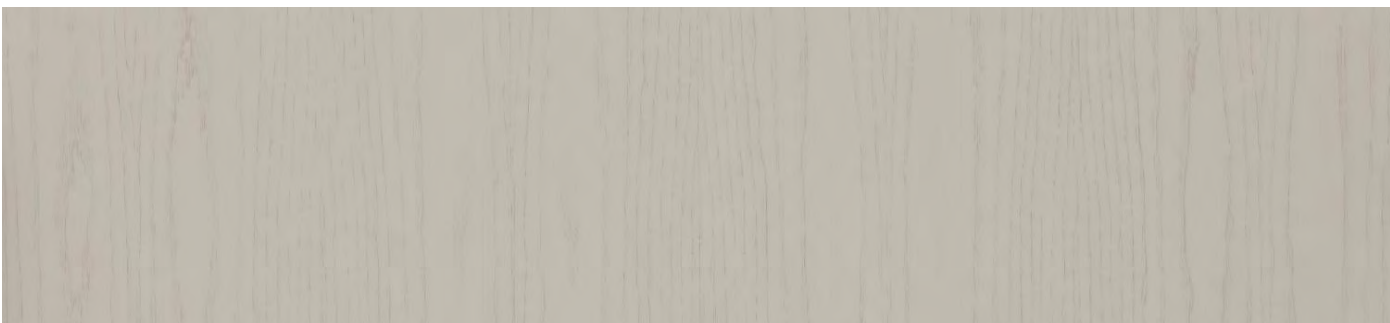

N.B.: la riproduzione su materiali diversi può riportare leggere differenze cromatiche rispetto agli originali.
NOTE: slight chromatic differences may result due to reproduction on different materials.

frassino verde | *grey ashwood* - SMANIA NEST

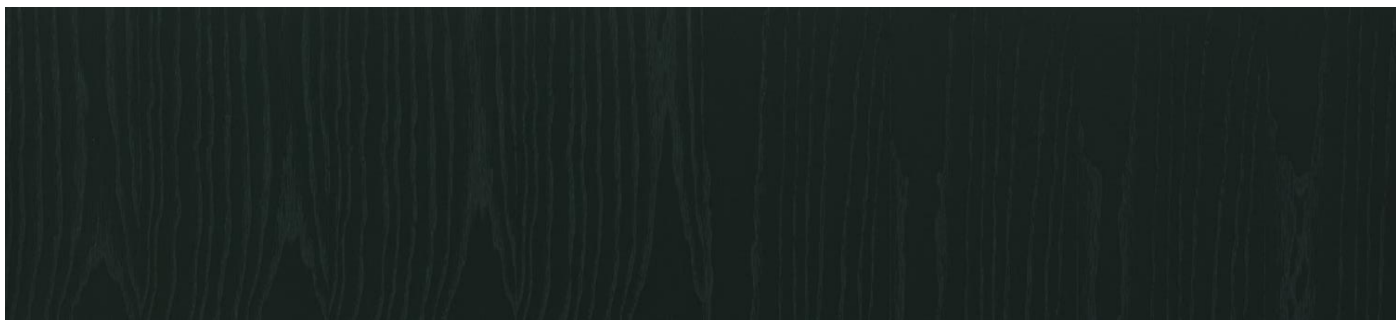

beige lucida | *beige polished lacquer*

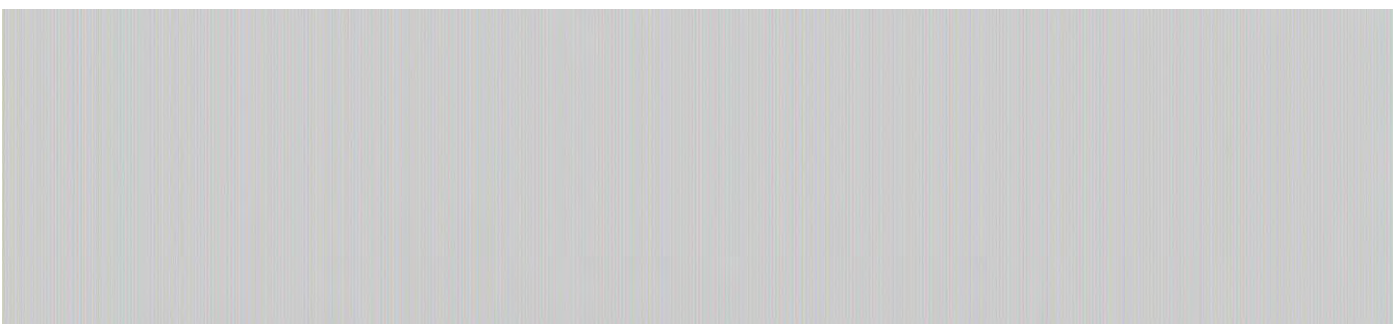

nera lucida | *black polished lacquer*



cipria lucida | *powder polished lacquer*

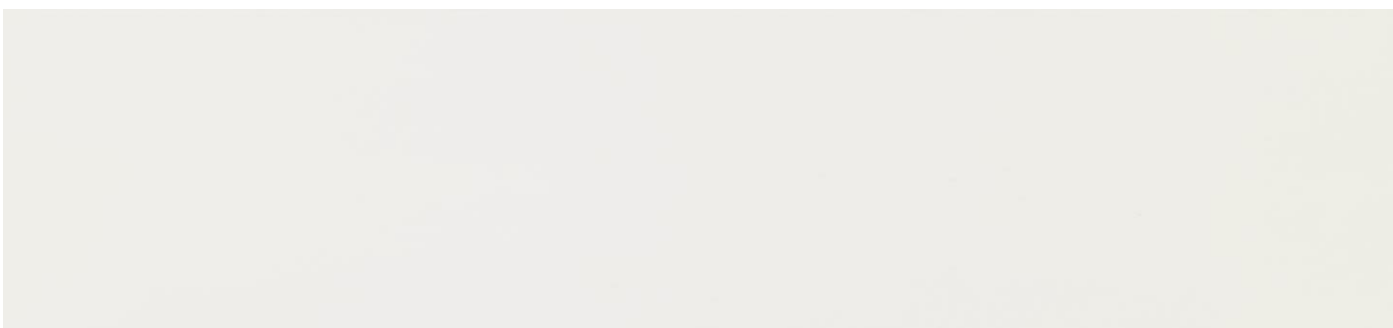

liquirizia lucida | *licorice polished lacquer*

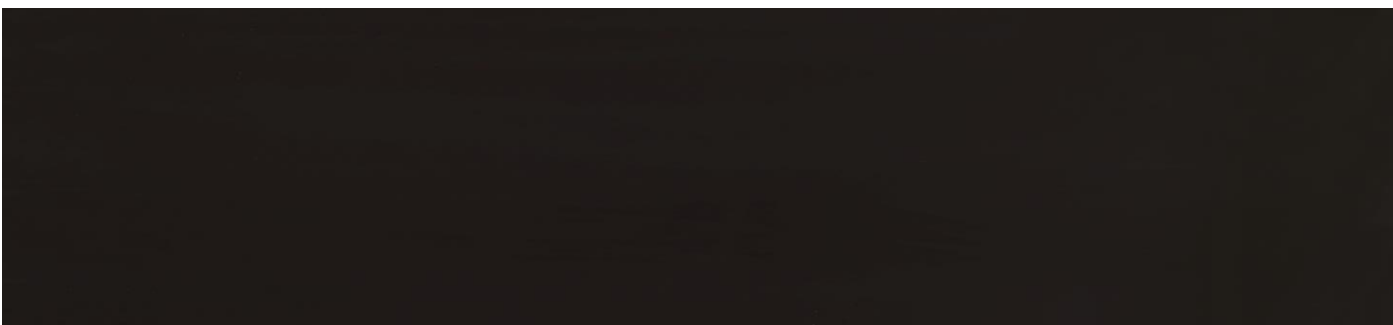

creta lucida | *clay polished lacquer*



N.B.: la riproduzione su materiali diversi può riportare leggere differenze cromatiche rispetto agli originali.

NOTE: slight chromatic differences may result due to reproduction on different materials.

ghisa lucida | *iron polished lacquer*

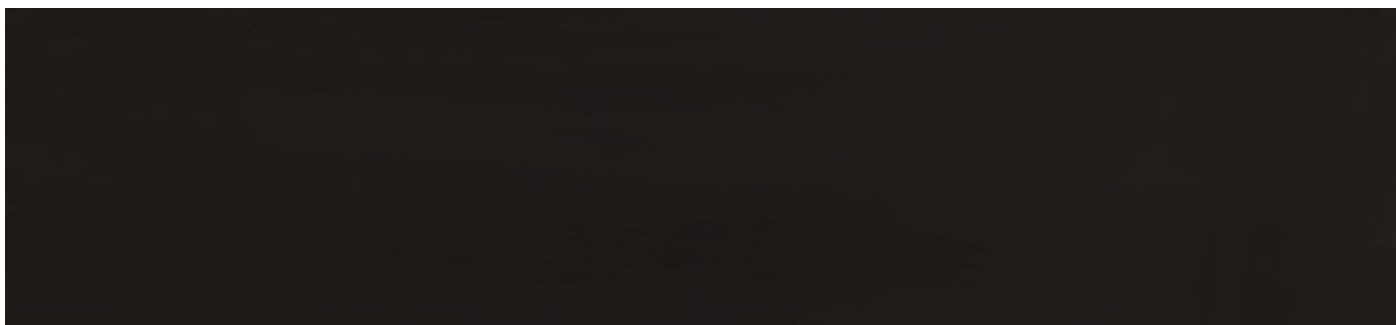

N.B.: la riproduzione su materiali diversi può riportare leggere differenze cromatiche rispetto agli originali.
NOTE: slight chromatic differences may result due to reproduction on different materials.

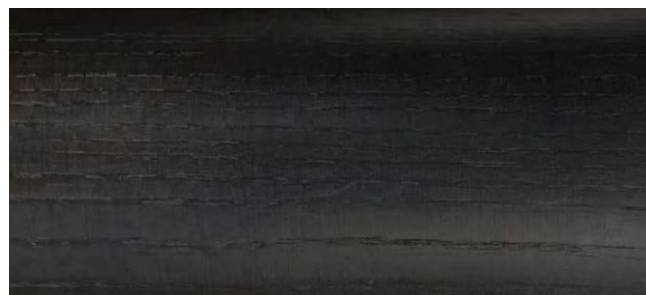
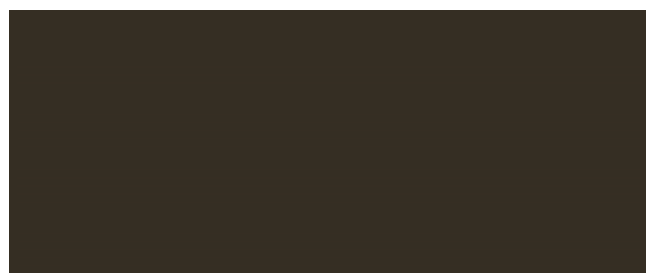
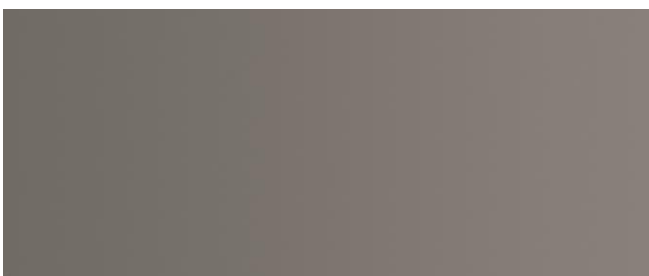
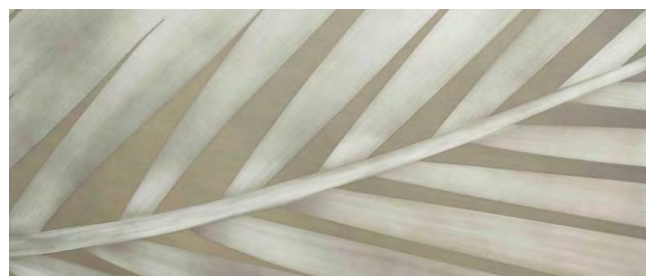
profili | *profiles - SMANIA NEST*miele
honeytesta di moro
*testa di moro*cuoio | *hide - ELLEN / SMANIA NEST*sabbia
sandtesta di moro
*testa di moro*superfici | *surfaces - SMANIA NEST*cristallo bronzo
bronze glasscristallo "decoro foglia"
"decoro foglia" glassceramica "calce bianco"
"calce bianco" ceramic

labradorite | *labradorite*

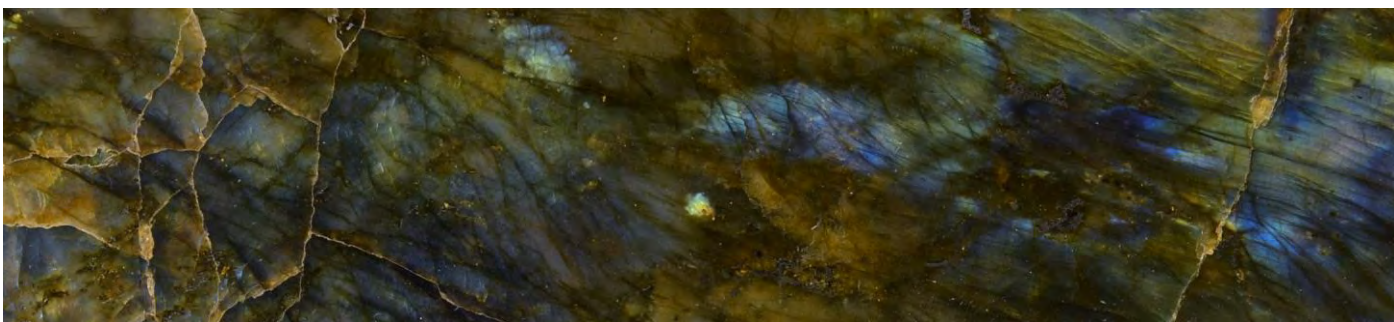

malachite | *malachite*

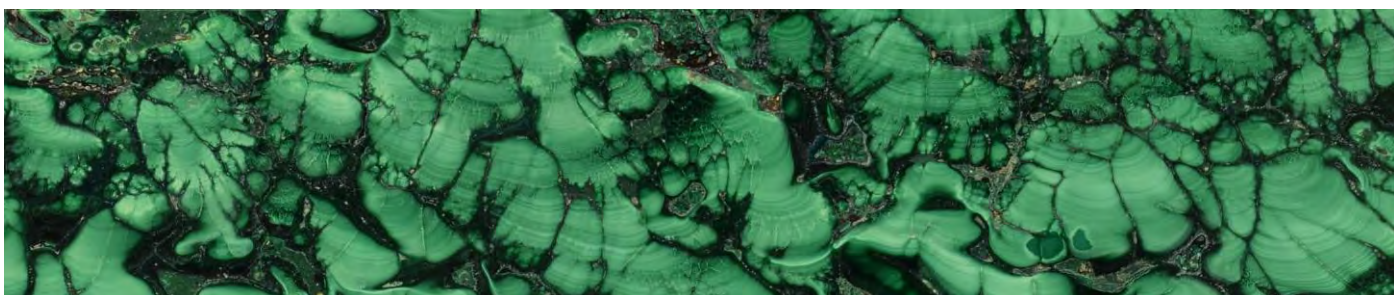

occhio di ferro | *iron eye*

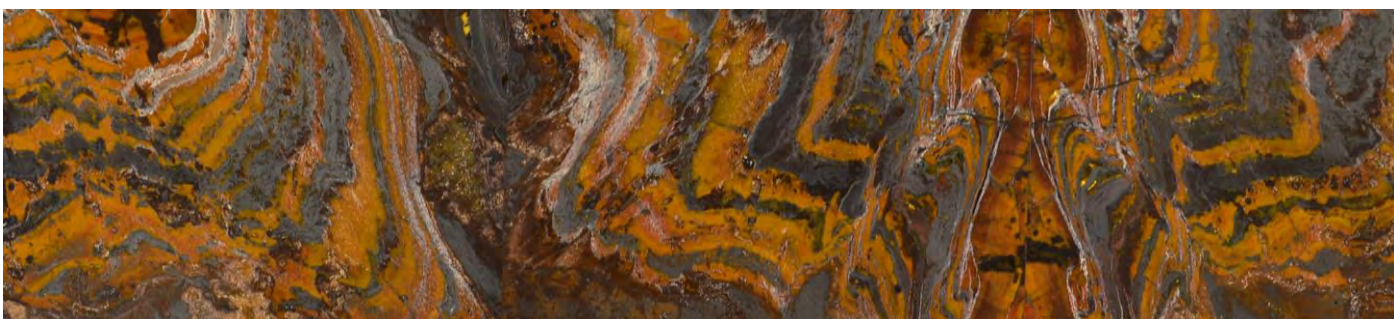

occhio di tigre | *tiger eye*

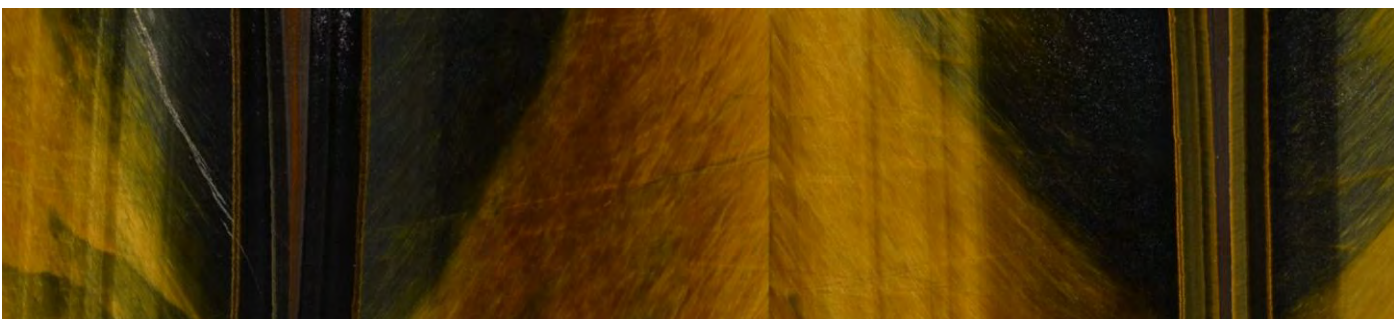

N.B.: la riproduzione su materiali diversi può riportare leggere differenze cromatiche rispetto agli originali.
NOTE: slight chromatic differences may result due to reproduction on different materials.



acciaio
polished stainless steel

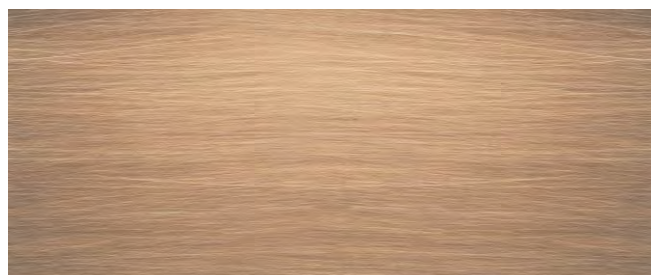

brunito spazzolato
brushed bronzed

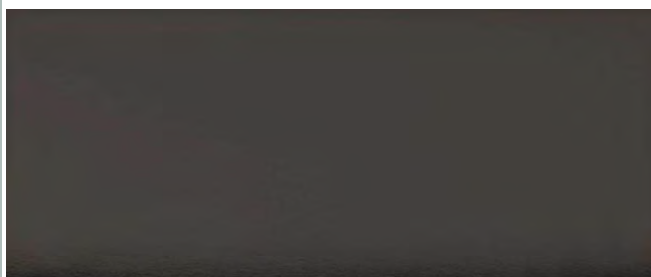

nichel nero
polished black nickel



nichel spazzolato
brushed nickel

metallo effetto satinato opaco | *matt glazed effect steel*



ghiaccio
ice

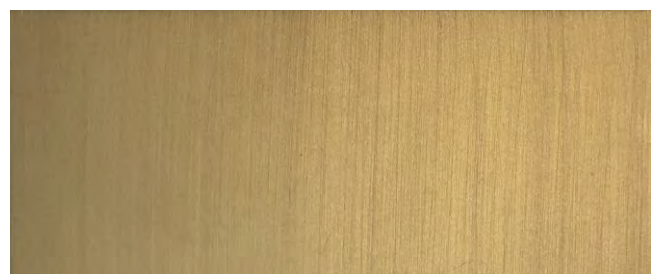

miele
honey

N.B.: I dettagli in acciaio spazzolato o effetto satinato opaco dei nostri mobili vengono spazzolati a mano, dunque è da ritenersi normale la non uniformità dei segni superficiali tipici della spazzolatura manuale

NOTE: The brushed or matt glazed effect steel details of our furniture are manually hand brushed so the non-uniformity of the typical superficial signs of the manual brushing are not to be considered a defect

N.B.: la riproduzione su materiali diversi può riportare leggere differenze cromatiche rispetto agli originali.

NOTE: slight chromatic differences may result due to reproduction on different materials.



06 antracite
06 dark grey



62 ecrù
62 ecru



5 grigio
5 grey



60 marrone
60 brown

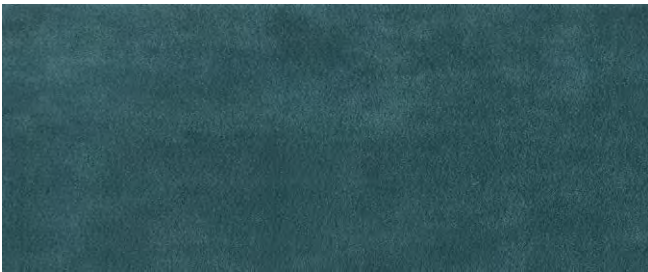

46 menta
46 mint green



7 nero
7 black



3 petalo
3 misty rose

antea / antea

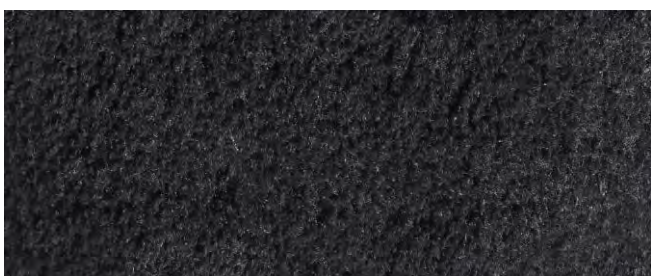

09 antracite
09 dark grey

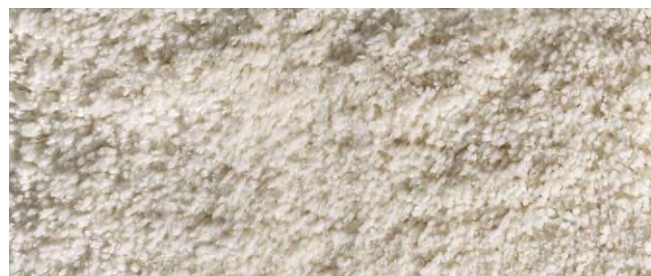

06 avorio
06 ivory

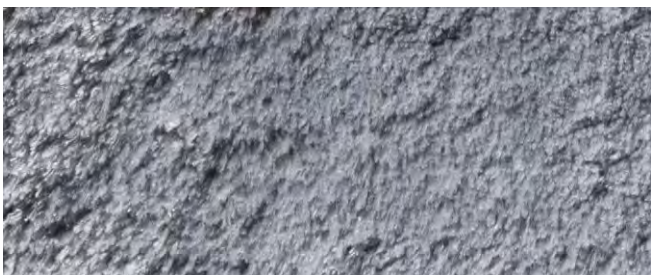

03 cielo
03 blue sky



04 rame
04 copper

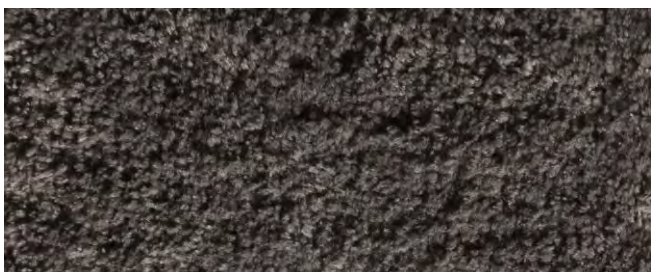

07 tortora
07 dove grey

viscosa / viscose



08 pergamena
08 vellum



10 rame
10 copper

N.B.: la riproduzione su materiali diversi può riportare leggere differenze cromatiche rispetto agli originali.
NOTE: slight chromatic differences may result due to reproduction on different materials.

coyote | *coyote*



coyote
coyote

lapin | *lapin*

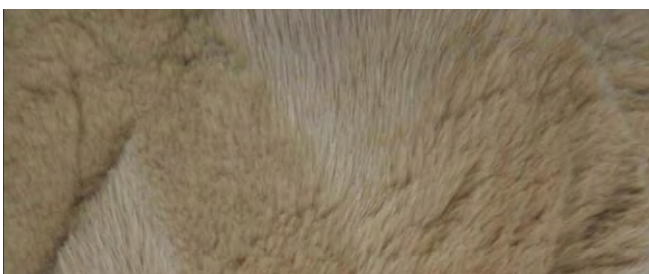

beige
beige



marrone
brown

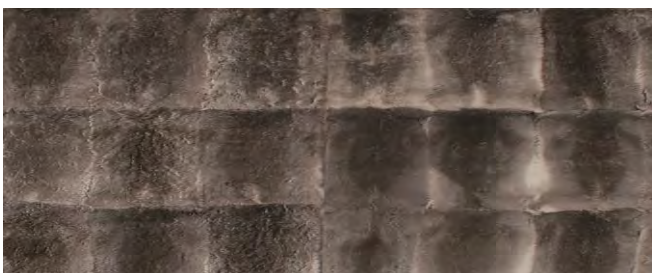

melange grigio
grey melange



menta
mint green

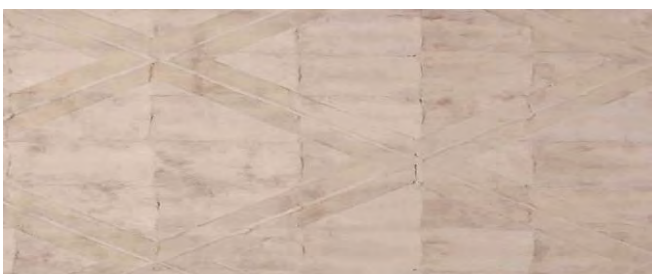

perla
pearl



rubino
ruby red

N.B.: la riproduzione su materiali diversi può riportare leggere differenze cromatiche rispetto agli originali.
NOTE: slight chromatic differences may result due to reproduction on different materials.

PELLICCIA | *FUR*

montone | *sheepskin*

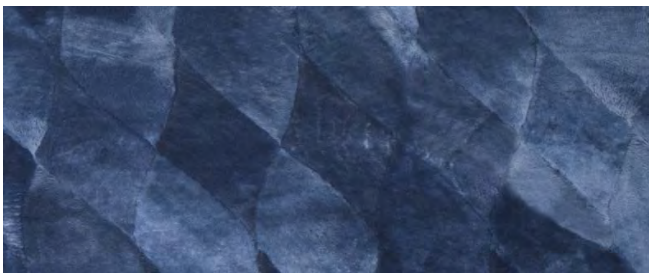

brisa cielo
blue sky brisa

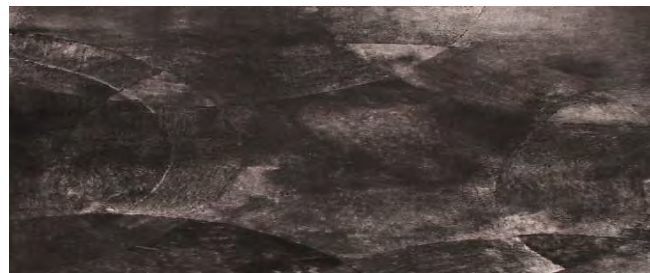

brisa grigio
grey brisa

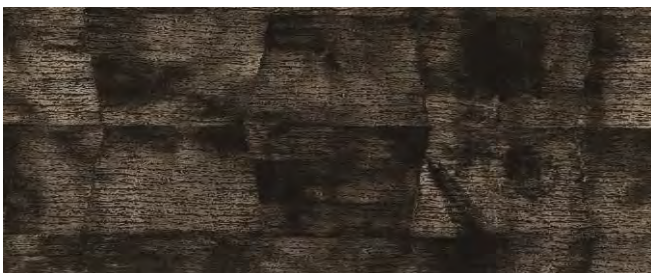

merino corneza
merino corneza



mussman marrone
brown mussman

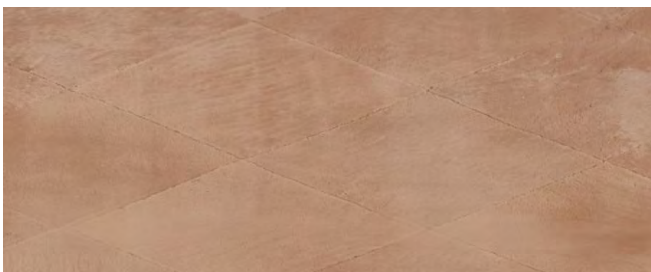

natural beige
beige natural

murmasky | *murmasky*



murmasky
murmasky

volpe | fox



volpe argentata
blue sky brisa



volpe rossa
red fox

azul macaubas | azul macaubas



calacatta cielo | calacatta cielo



calacatta gold | calacatta gold

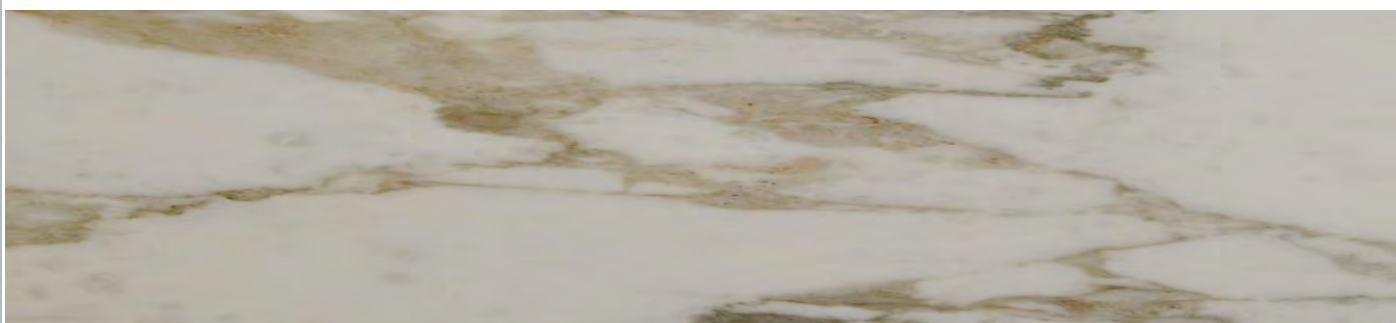

emperador dark | emperador dark

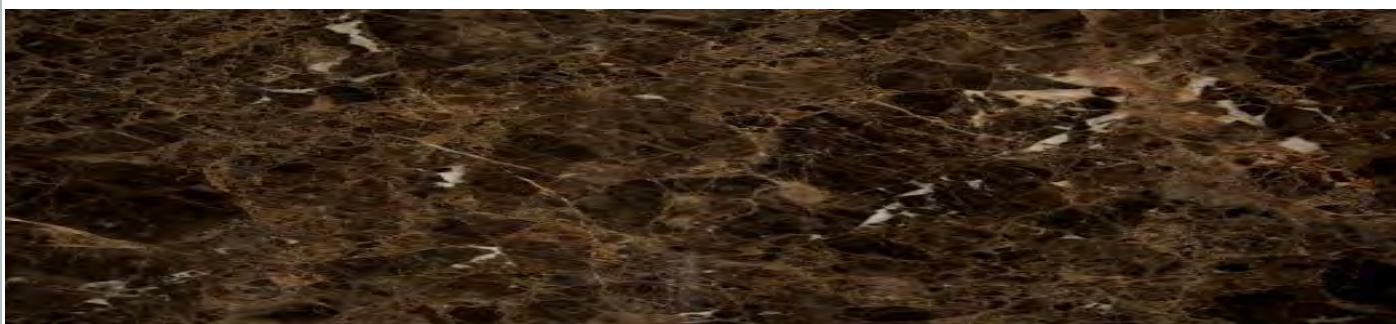

nero marquinia | nero marquinia



N.B.: la riproduzione su materiali diversi può riportare leggere differenze cromatiche rispetto agli originali.
NOTE: slight chromatic differences may result due to reproduction on different materials.

silver wave | *silver wave*





ABBY poltrona / *armchair* - IMBOTTITI / *UPHOLSTERY*, **3**
ALMA vassoio grande / *big tray* - COMPLEMENTI / *COMPLEMENTS*, **75**
ALMA vassoio medio / *medium tray* - COMPLEMENTI / *COMPLEMENTS*, **75**
ALMA vassoio piccolo / *small tray* - COMPLEMENTI / *COMPLEMENTS*, **75**
ANITHA credenza / *sideboard* - CREDENZE / *SIDEBOARDS*, **31**
ANTILLIA sedia / *chair* - SEDIE E SGABELLI / *CHAIRS AND STOOLS*, **27**
ATLANTIS letto matrimoniale / *double bed* - LETTI / *BEDS*, **47**
ATLANTIS US STANDARD KING SIZE letto matrimoniale / *king size double bed* - LETTI / *BEDS*, **48**
ATLANTIS 120 letto singolo / *single bed* - LETTI / *BEDS*, **49**
AZAR specchio / *mirror* - SPECCHI / *MIRRORS*, **45**
BRIGITTE consolle / *console* - CONSOLLE / *CONSOLE TABLES*, **43**
CAREY poltrona bassa / *low chair* - POLTRONE UFFICIO / *OFFICE CHAIRS*, **42**
CAREY poltrona direzionale / *directional chair* - POLTRONE UFFICIO / *OFFICE CHAIRS*, **41**
CASSIDY 190 mobile contenitore / *cabinet* - CREDENZE / *SIDEBOARDS*, **33**
CASSIDY 207 HIGH credenza / *sideboard* - CREDENZE / *SIDEBOARDS*, **34**
CASSIDY 280 mobile contenitore / *cabinet* - CREDENZE / *SIDEBOARDS*, **32**
CHAMBORD tavolo alto / *high table* - TAVOLI / *TABLES*, **23**
CHARLOTTE 210 divano / *sofa* - IMBOTTITI / *UPHOLSTERY*, **6**
CHARLOTTE 240 divano / *sofa* - IMBOTTITI / *UPHOLSTERY*, **5**
CHARLOTTE 280 divano / *sofa* - IMBOTTITI / *UPHOLSTERY*, **4**
CHARLOTTE poltrona / *armchair* - IMBOTTITI / *UPHOLSTERY*, **7**
CHARME 210 divano / *sofa* - IMBOTTITI / *UPHOLSTERY*, **10**
CHARME 240 divano / *sofa* - IMBOTTITI / *UPHOLSTERY*, **9**
CHARME 280 divano / *sofa* - IMBOTTITI / *UPHOLSTERY*, **8**
CHARME poltrona / *armchair* - IMBOTTITI / *UPHOLSTERY*, **11**
DEVON 19 tappeto / *carpet* - TAPPETI / *CARPETS*, **65**
EGLE vassoio grande / *big tray* - COMPLEMENTI / *COMPLEMENTS*, **76**
EGLE vassoio piccolo / *small tray* - COMPLEMENTI / *COMPLEMENTES*, **76**
ELLEN poltrona / *armchair* - IMBOTTITI / *UPHOLSTERY*, **12**
ELLEN sedia / *chair* - SEDIE E SGABELLI / *CHAIRS AND STOOLS*, **28**
ERMETE mobile trucco / *vanity desk* - CASSETTONI, COMODINI E MOBILI TRUCCO / *DRESSERS, NIGHTSTANDS AND VANITY DESKS*, **56**
FLINT 160 tavolo alto / *high table* - TAVOLI / *TABLES*, **26**
FLINT 200 tavolo alto / *high table* - TAVOLI / *TABLES*, **25**
FLINT 240 tavolo alto / *high table* - TAVOLI / *TABLES*, **24**
FLOYD consolle / *console* - CONSOLLE / *CONSOLE TABLES*, **44**
FRANK scrivania / *desk* - SCRITTOI, SCRIVANIE, ALLUNGHI / *DESKS AND DESK-EXTENSIONS*, **39**
HARRIET 130 tavolo basso / *coffee table* - TAVOLI / *TABLES*, **20**
HARRIET 140 tavolo basso / *coffee table* - TAVOLI / *TABLES*, **19**
HARRIET 85 tavolo basso / *coffee table* - TAVOLI / *TABLES*, **21**
INES sedia / *chair* - SEDIE E SGABELLI / *CHAIRS AND STOOLS*, **28**
KEPLERO lampadario / *chandelier* - ILLUMINAZIONE / *LIGHTING*, **61**
KIDA 140 cassettoni / *dresser* - CASSETTONI, COMODINI E MOBILI TRUCCO / *DRESSERS, NIGHTSTANDS AND VANITY DESKS*, **53**
KIDA 190 cassettoni / *dresser* - CASSETTONI, COMODINI E MOBILI TRUCCO / *DRESSERS, NIGHTSTANDS AND VANITY DESKS*, **52**
KIDA comodino / *dresser* - CASSETTONI, COMODINI E MOBILI TRUCCO / *DRESSERS, NIGHTSTANDS AND VANITY DESKS*, **51**
KILLIAN 235 divano / *sofa* - IMBOTTITI / *UPHOLSTERY*, **14**
KILLIAN 270 divano / *sofa* - IMBOTTITI / *UPHOLSTERY*, **13**
KILLIAN 345 divano angolo dx / *corner sofa dx* - IMBOTTITI / *UPHOLSTERY*, **15**
KILLIAN 345 divano angolo sx / *corner sofa sx* - IMBOTTITI / *UPHOLSTERY*, **16**
KILLIAN poltrona / *armchair* - IMBOTTITI / *UPHOLSTERY*, **17**
KLIZIA letto matrimoniale / *double bed* - LETTI / *BEDS*, **50**
KLIZIA US STANDARD KING SIZE letto matrimoniale / *king size double bed* - LETTI / *BEDS*, **51**
KLIZIA poltrona / *armchair* - IMBOTTITI / *UPHOLSTERY*, **18**
LUDWIG colonna libreria / *bookcase column* - LIBRERIE / ESPOSITORI, MOBILI BAR E CONTENITORI / *BOOKCASES / SHOWCASES, HOME THEATRES, BAR UNITS AND CABINETS*, **37**
MERA vetrinetta / *cabinet* - LIBRERIE / ESPOSITORI, MOBILI BAR E CONTENITORI / *BOOKCASES / SHOWCASES, HOME THEATRES, BAR UNITS AND CABINETS*, **38**
NIVES vaso alto / *high vase* - COMPLEMENTI / *COMPLEMENTS*, **77**
NIVES vaso basso / *low vase* - COMPLEMENTI / *COMPLEMENTS*, **77**
PALM LEAVES pannello decorativo / *decorative panel* - PANNELLI DECORATIVI / *DECORATIVE PANELS*, **71**
PALM tappeto / *carpet* - TAPPETI / *CARPETS*, **66**
SAMSARA applique / *applique* - ILLUMINAZIONE / *LIGHTING*, **59**
SAMSARA lampada da tavolo / *table lamp* - ILLUMINAZIONE / *LIGHTING*, **57**
SAMSARA lampada da terra / *floor lamp* - ILLUMINAZIONE / *LIGHTING*, **58**
SCULTURA lampada da terra / *floor lamp* - ILLUMINAZIONE / *LIGHTING*, **60**

SEED pannello decorativo / *decorative panel* - PANNELLI DECORATIVI / *DECORATIVE PANELS*, 72
SHUTTLE lampada da tavolo / *table lamp* - ILLUMINAZIONE / *LIGHTING*, 61
SHUTTLE lampada da terra / *floor lamp* - ILLUMINAZIONE / *LIGHTING*, 62
SWEET tappeto / *carpet* - TAPPETI / *CARPETS*, 67
THORN_19 tappeto / *carpet* - TAPPETI / *CARPETS*, 68
TROPIC tappeto / *carpet* - TAPPETI / *CARPETS*, 69
TWEED credenza / *sideboard* - CREDENZE / *SIDEBOARDS*, 35
WEBER DEEP pannello decorativo / *decorative panel* - PANNELLI DECORATIVI / *DECORATIVE PANELS*, 73
ZAREN tavolo appoggio / *side table* - TAVOLI / *TABLES*, 21

- 1. LISTINO PREZZI.** Il presente listino annulla e sostituisce ogni altro precedente ivi comprese le condizioni di vendita e può essere modificato in qualsiasi momento senza preavviso. I prezzi si intendono al pubblico I.V.A. ed eventuale montaggio esclusi.
- 2. CONSEGNE / RITIRO MERCE.** I tempi di consegna espressi in commissione e conferma d'ordine si intendono indicativi: eventuali ritardi non potranno dare adito a pretese di alcun tipo da parte dell'acquirente. In caso di qualsiasi variazione dell'ordine i tempi di consegna varieranno di conseguenza. Per data di consegna si intende che la merce ordinata è pronta alla spedizione presso i nostri magazzini. Trascorsi 21 giorni dalla data di notifica scritta di merce pronta, qualora il cliente non intenda ricevere/ritirare la merce, la Smania Industria Italiana Mobili S.p.A. (di seguito Smania) può offrire un "servizio aggiuntivo" per il magazzinaggio della stessa presso la propria sede al costo di € 6,00 a metro cubo al giorno. Nel caso in cui il cliente non volesse usufruire di questo servizio dovrà necessariamente provvedere al ricevimento/ritiro della stessa entro il termine suddetto. Qualora concorrano più ordini, il mancato pagamento totale o parziale anche di uno solo di essi autorizzerà Smania a sospendere tutte le consegne in corso, salvo comunque l'ulteriore risarcimento dei danni.
- 3. VARIAZIONI E/O ANNULLAMENTI.** Eventuali richieste di variazione e/o annullamenti d'ordine da parte dell'acquirente dovranno pervenire in forma scritta (per posta, e-mail o fax) alla Smania entro e non oltre 8 gg lavorativi dalla ricezione della conferma d'ordine. La Smania previa verifica di fattibilità, comunicherà in ogni caso all'acquirente se la richiesta è stata accettata o meno.
- 4. RICHIESTE SPECIALI DI MODIFICHE SUL PRODOTTO DI SERIE.** Eventuali richieste di modifiche sono possibili solo se approvate da Smania, dopo averne valutato la possibilità. La quotazione ed il tempo di esecuzione saranno preventivati caso per caso.
- 5. IMBALLO.** La merce viene imballata nei modi più idonei e tutti gli imballi vengono controllati per evitare qualsiasi danno causato dal trasporto. L'imballo è gratuito. L'acquirente sarà responsabile per un corretto ed adeguato disimballaggio. Qualsiasi danno causato da un disimballaggio improprio sarà a carico dell'acquirente. Richiesta di imballi speciali in gabbie, casse di legno o scatole particolari comporteranno una maggiorazione del 15% sul prezzo di listino.
- 6. TRASFERIMENTO DELLA PROPRIETÀ E TRASPORTO.** Nel caso di trasporto dei beni compravenduti, la proprietà si intenderà trasferita all'acquirente dal momento della consegna degli stessi da parte di Smania al vettore incaricato del trasporto; da tale momento Smania è sollevata da ogni rischio e responsabilità relativamente ai beni. La merce viaggia in porto franco, sul territorio italiano, per importi netti da € 850,00; con contributo trasporto in ragione del 6% (con un minimo di € 35,00) per importi inferiori. Eventuali spese di facchinaggio, per consegne in luoghi non accessibili a camion o altre richieste particolari, dovranno essere preventivamente concordate e saranno addebitate in ragione di € 15,00/ora.
- 7. COLLAUDO E ACCETTAZIONE.** Eventuali richieste di documentazione fotografica degli arredi ordinati dovranno essere fatte al momento della conferma dell'ordine. Qualora tali richieste avvenissero nel momento in cui gli articoli risultino già imballati, Smania avrà la facoltà di addebitare gli eventuali costi di movimentazione, disimballo e nuovo imballo della merce, quantificabili in euro 100 per ogni singolo collo. All'atto di ricezione della merce, il rilascio di firma per ricevuta da parte dell'acquirente, su documenti accompagnatori o simili, costituisce prova di avvenuto collaudo. L'acquirente ha l'obbligo, entro 8 giorni di calendario a far data dal ricevimento, di controllare la merce ricevuta. Qualsiasi contestazione in merito a: (i) difformità delle merci consegnate, (ii) condizioni, (iii) presenza di eventuali vizi o difetti palesi e qualità promessa, unitamente ai contrassegni dei colli contestati, deve essere segnalata in forma scritta per fax o e-mail alla Smania. Qualora entro 8 giorni di calendario dalla consegna non vengano formulate contestazioni, la merce si intenderà integralmente accettata fatta salva la presenza di vizi occulti, in presenza dei quali le parti si richiamano alle vigenti norme di legge. Alla segnalazione della contestazione la Smania invierà all'acquirente un modulo Assistenza Clienti che quest'ultimo dovrà debitamente compilare e rispedire a Smania, assieme a foto che evidenzino chiaramente il difetto o il danno, per permettere a Smania di effettuare una corretta valutazione dello stesso. Eventuali danni, palesemente subiti dalla merce durante il trasporto, dovranno essere denunciati al trasportatore in forma scritta, con copia alla Smania, entro 8 giorni di calendario dal ricevimento della merce.
- 8. QUALITÀ DEI PRODOTTI.** Eventuali differenze di tonalità di colore, venatura, sezione, assorbimento delle tinte, rispetto alle stampe del catalogo, non sono da intendersi come mancata conformità, vizio o difetto.
- 9. RESI.** I resi di merce non potranno essere effettuati, salvo autorizzazione scritta da parte di Smania. Pertanto dovranno essere conservati tutti gli imballi originali, in caso di utilizzo per la restituzione della merce ritenuta difettosa.
- 10. GARANZIA.** Smania garantisce che i prodotti rispondono ai migliori processi di produzione e che sono privi di ogni difetto per un periodo di 2 (due) anni dalla data di consegna quando usati in condizioni standard. La garanzia è esclusa nel caso di uso ed immagazzinaggio improprio, cattiva manutenzione e/o in caso di danni non imputabili a Smania. La garanzia comporta, a facoltà di Smania e dopo apposita verifica, la sostituzione gratuita dei prodotti nei tempi normalmente occorrenti oppure l'accredito del controvalore.
- 11. PAGAMENTI.** I pagamenti dovranno essere eseguiti in conformità a quanto espresso sulla fattura emessa dall'azienda (importi, modalità, banca d'appoggio, etc.). Per nessun motivo e a nessun titolo l'acquirente potrà differire o sospendere i pagamenti oltre le scadenze pattuite, a meno che il pagamento non sia stato effettuato in anticipo. Il mancato pagamento di una sola fattura alla sua scadenza comporterà per l'acquirente la decadenza del beneficio del termine per tutte le altre. Smania potrà comunque richiedere all'acquirente il pagamento dei beni compravenduti, anche prima che siano decorsi i termini di pagamento, qualora mutino le condizioni economiche dell'acquirente al punto da mettere in dubbio la sua solvibilità. I pagamenti non andati a buon fine daranno diritto alla Smania, in deroga alle disposizioni dell'art. 4 del D. Lgs. n. 231/2002, di addebitare gli interessi al momento in cui la costituzione in mora che potrà avvenire mediante lettera raccomandata A/R o altro atto di intimazione al pagamento. Verranno inoltre addebitate anche le eventuali spese bancarie, di bollo, nonché le spese amministrative sostenute da Smania.
- 12. CAPARRA CONFIRMATORIA E ACCONTO.** Su forniture speciali la Smania potrà richiedere un acconto o, a sua discrezione, una caparra confirmatoria pari al 50% (cinquantapercento) del valore della fornitura. Tale caparra è disciplinata dall'art. 1385 c.c. e dalle disposizioni di legge attualmente vigenti in materia.
- 13. MARCHIO.** È fatto divieto di utilizzo, con qualsiasi forma e modalità, da parte dell'acquirente del marchio SMANIA, fatta salva autorizzazione scritta di Smania.
- 14. PROPRIETÀ TECNICA DELLE OPERE.** Tutti i prodotti della Smania sono concepiti, disegnati, sviluppati e prodotti dalla Smania, pertanto di proprietà della Smania e conseguentemente tutelate ai termini di legge. In particolare nessuno è autorizzato a riprodurli fotostaticamente od in altro modo, utilizzare le informazioni contenute per la realizzazione totale o parziale, di opere aventi simili natura e caratteristiche, divulgare i contenuti a fini di concorrenza sleale etc. In difetto la Smania si riserva il diritto di intraprendere ogni e qualsiasi azione di rivalsa nei confronti degli eventuali trasgressori per il risarcimento dei danni subiti, i quali, essendo stati debitamente informati in questa sede, non potranno invocare la buona fede.
- 15. ESCLUSIVITÀ DI VENDITA.** L'acquirente si impegna a non cedere, a qualsiasi titolo, ad alcun rivenditore e/o distributore i prodotti acquistati da Smania, salvo espressa autorizzazione scritta di quest'ultima. Si impegna altresì a non cedere i prodotti acquistati a punti vendita diversi da quello ove i prodotti sono stati consegnati.
- 16. DIRITTO DI RECESSO DEL PRODUTTORE.** La Smania si riserva il diritto di recedere dall'ordine a proprio insindacabile giudizio e senza che ciò possa essere preteso per azioni di rivalsa da parte dell'acquirente o di terzi ad alcun titolo.
- 17. TUTELA DEI DATI PERSONALI.** I dati personali forniti dall'acquirente sono utilizzati al fine dell'esecuzione del Contratto di vendita, per tutta la durata dello stesso. L'interessato, secondo quanto previsto dalla normativa sulla tutela dei dati personali, può accedere ai propri dati, chiedendone la correzione, l'integrazione e, ricorrendone gli estremi la cancellazione o il blocco.
- 18. FORO COMPETENTE E LEGGE APPLICABILE.** In caso di eventuale controversia viene fin d'ora eletto a foro competente il tribunale di Venezia e sarà applicata la legge italiana.

1. **PRICE LIST.** This price list deletes and replaces any previous price lists, including the sale conditions, and may be modified at any time without advanced notice. Prices indicated in the list are "retail prices". Unless differently specified or agreed on a case by case basis, our prices are "Ex Works" and therefore transportation is excluded. VAT and/or any installations are explicitly excluded.
2. **DELIVERY / COLLECTION.** The delivery time indicated in the preliminary order as well as in the order acknowledgment is an estimate: any delays shall not give grounds to any type of claims by the Buyer. In case of modifications to the order, when so requested by the Buyer, the delivery time will be modified accordingly. The date of delivery is the date on which the goods will be ready for shipment at our warehouses. After 21 days from written notice by Smania of goods readiness, in case the Buyer does not intend to receive/retrieve the goods, Smania Industria Italiana Mobili S.p.A. (as of now known as Smania) will offer an "additional storage service" at its warehouse, at € 6,00/cubic meter/day charge. Should the Buyer reject this kind of service, he shall necessarily have to organize the loading/receiving of the goods within such deadline. In case of multiple orders, should one or more outstanding payments be in default, Smania shall be entitled to withhold all remaining deliveries, subject however to additional damage compensations.
3. **ORDER MODIFICATIONS AND/OR CANCELLATIONS.** Any requests for modifications and/or cancellations to the order must be submitted to Smania, in writing, by and not later than 8 business days from reception of the order confirmation. Such requests may be submitted by email or fax. Based on the technical feasibility of the modification or cancellation, Smania shall notify the Buyer if the request is accepted or rejected.
4. **SPECIAL REQUESTS FOR MODIFICATIONS TO STANDARD PRODUCTS.** Product modifications are possible only if explicitly approved in writing by Smania, after having assessed the relevant technical feasibility. The cost and delivery time shall be estimated on a case by case basis.
5. **PACKING.** All goods are packed in the best suitable manner and all packages are checked in order to avoid all and any damages caused by transportation. Packing is free of charge. The Buyer shall be responsible for proper and sound unpacking. All and any damages caused by improper unpacking shall be borne by the Buyer. Any requests for special packing in crates, wooden boxes or containers will involve a 15% surcharge on the listed price.
6. **TRANSFER OF OWNERSHIP (EX WORKS).** The ownership of the goods will be transferred to the Buyer when the goods are handed over to the carrier. Therefore, from such moment onwards Smania is relieved from any liabilities of whatever nature connected with such goods.
7. **INSPECTION AND ACCEPTANCE.** Any request for photographic documentation of the furniture ordered will have to be made upon confirmation of the order. If these requests should come forth when the items have been packed or ready for shipping, Smania will have the right to charge for any costs of handling & packing, amounting to euro 100 for each individual item. It is the Buyer's obligation to inspect the goods received within 8 calendar days from the date of reception. Any notifications concerning dissimilarities of the delivered goods, their conditions, the presence of any evident flaws or defects, or the promised quality, together with the list of the packages involved, must be submitted in writing by fax or email. Should no complaints be raised within the 8 working days term, the goods shall be deemed as fully accepted, except in case of hidden defects, for which the current provisions of the law will be applicable. At the time of the above notification Smania shall provide the Buyer with a Customer Service Request form which the Buyer will have to fill in and submit to Smania – together with clear pictures of the defects or damages – in order to allow Smania to initiate a proper assessment of the defect or damage.
8. **PRODUCT QUALITY.** Any differences in colour tones, grain, cross section, colour absorption, etc., from the catalogue prints shall not be considered as a non-conformity, flaw or defect.
9. **RETURNS.** The goods shall not be returned, unless specifically authorized by Smania. Therefore, all original packaging material must be saved during unpacking, in order to be used to return any defective goods.
10. **WARRANTY.** Smania represents and warrants that the products respond to the Best Manufacturing Practice and that they are therefore free from any defects for a period of 2 (two) years from the date of delivery when used in standard conditions. The warranty is excluded in case of improper use and storage, bad maintenance or in case of damages caused to products for reasons not due to Smania's fault. The warranty entails, at the sole discretion of Smania and after technical verification, either a free of charge replacement of the products within the normal delivery terms, or a credit note equivalent to the replacement value.
11. **PAYMENTS.** Payments shall be made in accordance with the terms indicated in the invoice issued by Smania (amounts, procedures, bank, etc.). The Buyer may not, for any reasons and purposes whatsoever, delay or suspend payments beyond the agreed terms, unless the goods have been fully paid in advance. In case of multiple invoices and/or payments, failure to pay even a single invoice by the due date shall cause the Buyer's loss of the benefit of the term for all the other outstanding invoices. Smania may however request the Buyer to pay the goods, even before the expiry of the payment terms, should the economic conditions of the Buyer change and cast doubts on his solvency. Notwithstanding the provisions of Article 4, Italian Law number 231/2002, any uncollected payments will entitle Smania, to charge the Buyer with interests as of the notice of default, which shall be notified to the Buyer by registered letter or by any other payment intimation means. Any bank charges, stamp dues or fees, as well as any administrative costs incurred by Smania, will also be debited to the Buyer.
12. **CONFIRMATION DEPOSIT AND ADVANCE PAYMENT.** On special supplies, Smania may request, at its sole discretion, an advance payment or a confirmation deposit up to 50% (fifty percent) of the supply value. Such deposit is ruled by Art. 1385 of the Italian Civil Code and by the relevant applicable law provisions.
13. **TRADE MARK.** The Buyer shall not use the SMANIA trade mark in any form or manner whatsoever, without the previous written authorization by Smania.
14. **TECHNICAL PROPERTY OF THE PRODUCTS.** All Smania products are conceived, designed, developed and manufactured by Smania and, therefore, all IP rights belong to Smania and are protected in accordance with the law. In particular, no third party is authorized to: (i) copy, photocopy or reproduce in any way whatsoever pictures, drawings and all technical and commercial material of whatever nature and kind, (ii) manufacture and/or reproduce copies of the products, (iii) use any other information in order to produce and/or reproduce, totally or partially, works of similar nature and characteristics or disclose such information for purposes of unfair competition. In case of non-compliance with this article, Smania reserves its right to take appropriate legal action for compensation of suffered damages against all and any violators, and said violators, being duly informed herein, shall not plead good faith in their defence.
15. **EXCLUSIVE SELLING RIGHT.** The Buyer undertakes not to surrender, for any purposes whatsoever, to any reseller and/or distributor the products purchased from Smania, unless explicitly authorized to do so in writing by the latter. The Buyer also undertakes to refrain from transferring the purchased products to different Points of Sale other than the one where the products have been originally delivered.
16. **MANUFACTURER RIGHT OF WITHDRAWAL.** Smania reserves the right to withdraw from the order at its sole undisputable discretion without, by so doing, entitling the Buyer or third parties to take recourse of whatever nature.
17. **PROTECTION OF PERSONAL INFORMATION.** The personal information supplied by the Buyer is used for the execution of the contract and for the duration of the same. The Buyer, as foreseen by law on the "Privacy" protection, may have access to its own data, and may submit requests to correct, add, integrate, delete or freeze any data as the case may be.
18. **JURISDICTION AND APPLICABLE LAW.** The present Conditions of Sale are governed by the Italian Law and the competent Court is the one in Venice.



SMANIA Industria Italiana Mobili S.p.A.

via del Lavoro, 8/10
30030 Cazzago di Pianiga (VE) - Italy
P.IVA - VAT N. IT04663560284
T +39 041 5137700
F +39 041 464784
info@smania.it

www.smania.it